

**UC/CSUC - Utility Cabinet**

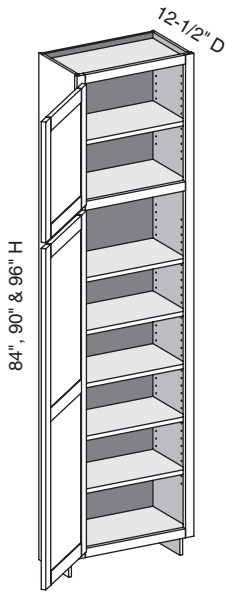

EXP	FL	FUE	SS	PFD	EXT	FT	SBR	LE	TSS	OS	NSH	WS	MI	DT	NB
✓	✓	✓		✓	✓	✓	✓	✓		✓	✓	✓	✓		

Custom Size Ranges  
Width: 12" – 24"  
Height: 84" – 120"  
Depth: 5-1/2" – 30"

- Matching specie interior is not available over 96" high. Natural Birch UV material will be used.
- When height changes, upper opening height changes. Lower opening height fixed at 56".
- 84" – 90" high has six shelves.
- 90-1/16" – 96" high has seven shelves.
- 96-1/16" – 108" high has eight shelves.
- 108-1/16" – 120" high has nine shelves.
- Separate 4" high toe platform available in all cabinet heights.
- Specify single or butt doors on custom size cabinets 24" wide.

84" High	90" High	96" High
UC1584	UC1590	UC1596
UC1884	UC1890	UC1896
UC2184	UC2190	UC2196
UC2484	UC2490	UC2496

**UC/CSUC - Utility Cabinet w/Butt Doors**

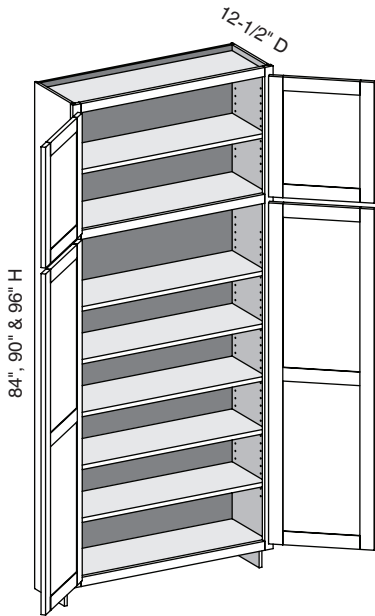

EXP	FL	FUE	SS	PFD	EXT	FT	SBR	LE	TSS	OS	NSH	WS	MI	DT	NB
✓	✓	✓		✓	✓	✓	✓	✓		✓	✓	✓	✓		

Custom Size Ranges  
Width: 24" – 36"  
Height: 84" – 120"  
Depth: 5-1/2" – 30"

- Matching specie interior is not available over 96" high. Natural Birch UV material will be used.
- When height changes, upper opening height changes. Lower opening height fixed at 56".
- 84" – 90" high has six shelves.
- 90-1/16" – 96" high has seven shelves.
- 96-1/16" – 108" high has eight shelves.
- 108-1/16" – 120" high has nine shelves.
- Separate 4" high toe platform available in all cabinet heights.
- Specify single or butt doors on custom size cabinets 24" wide.

84" High	90" High	96" High
UC2484BD	UC2490BD	UC2496BD
UC2784BD	UC2790BD	UC2796BD
UC3084BD	UC3090BD	UC3096BD
UC3384BD	UC3390BD	UC3396BD
UC3684BD	UC3690BD	UC3696BD

**Options Key:** EXP = Exposed End(s) FL = Flush End(s) FUE = Flush Unexposed End(s) SS = Shaped Side PFD = Prep for False Door  
EXT = Extended Stile(s) FT = Flush Toe SBR = Shaped Bottom Rail LE = Leg Extension TSS = Toe Space Side OS = Omit Shelving  
NSH = No Shelf Holes WS = Solid Wood Shelves MI = Matching Interior DT = Dust Top NB = Natural Finished Bottom

## UC/CSUCCS - Utility Cabinet w/Center Stile

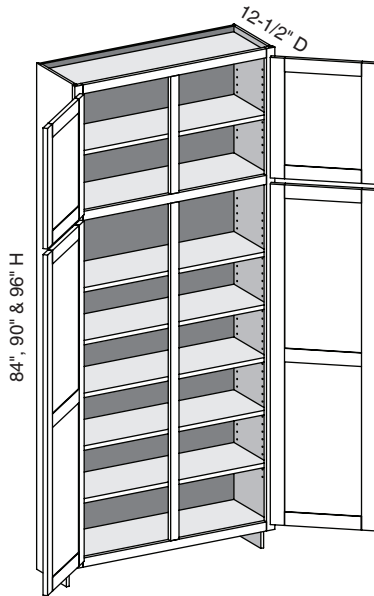

EXP	FL	FUE	SS	PFD	EXT	FT	SBR	LE	TSS	OS	NSH	WS	MI	DT	NB
✓	✓	✓		✓	✓	✓	✓	✓		✓	✓	✓	✓		

Custom Size Ranges  
 Width: 27" – 36"  
 Height: 84" – 120"  
 Depth: 5-1/2" – 30"

- Matching specie interior is not available over 96" high. Natural Birch UV material will be used.
- When height changes, upper opening height changes. Lower opening height fixed at 56".
- 84" – 90" high has six shelves.
- 90-1/16" – 96" high has seven shelves.
- 96-1/16" – 108" high has eight shelves.
- 108-1/16" – 120" high has nine shelves.
- Separate 4" high toe platform available in all cabinet heights.

84" High	90" High	96" High
UC2784	UC2790	UC2796
UC3084	UC3090	UC3096
UC3384	UC3390	UC3396
UC3684	UC3690	UC3696

## UCD/CSUC - Utility Cabinet Deep

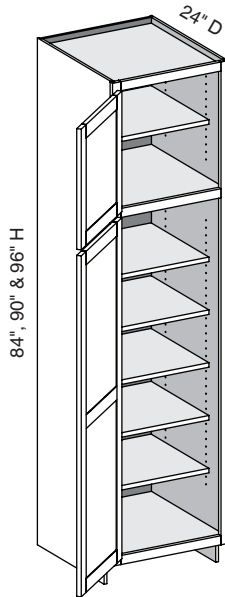

EXP	FL	FUE	SS	PFD	EXT	FT	SBR	LE	TSS	OS	NSH	WS	MI	DT	NB
✓	✓	✓	✓	✓	✓	✓	✓	✓	✓	✓	✓	✓	✓		

Custom Size Ranges  
 Width: 12" – 24"  
 Height: 84" – 120"  
 Depth: 5-1/2" – 30"

- Matching specie interior is not available over 96" high. Natural Birch UV material will be used.
- When height changes, upper opening height changes. Lower opening height fixed at 56".
- 84" – 90" high has six shelves.
- 90-1/16" – 96" high has seven shelves.
- 96-1/16" – 108" high has eight shelves.
- 108-1/16" – 120" high has nine shelves.
- Separate 4" high toe platform available in all cabinet heights.
- Specify single or butt doors on custom size cabinets 24" wide.

84" High	90" High	96" High
UCD1584	UCD1590	UCD1596
UCD1884	UCD1890	UCD1896
UCD2184	UCD2190	UCD2196
UCD2484	UCD2490	UCD2496

**Options Key:** EXP = Exposed End(s) FL = Flush End(s) FUE = Flush Unexposed End(s) SS = Shaped Side PFD = Prep for False Door  
 EXT = Extended Stile(s) FT = Flush Toe SBR = Shaped Bottom Rail LE = Leg Extension TSS = Toe Space Side OS = Omit Shelving  
 NSH = No Shelf Holes WS = Solid Wood Shelves MI = Matching Interior DT = Dust Top NB = Natural Finished Bottom

**UCD/CSUC - Utility Cabinet Deep w/Butt Doors**

EXP	FL	FUE	SS	PFD	EXT	FT	SBR	LE	TSS	OS	NSH	WS	MI	DT	NB
✓	✓	✓	✓	✓	✓	✓	✓	✓	✓	✓	✓	✓	✓		

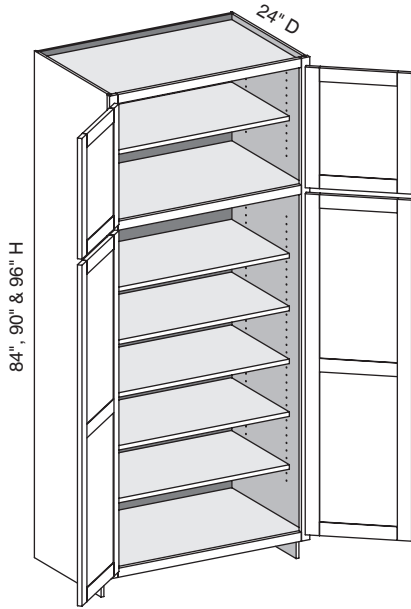

Custom Size Ranges  
Width: 24" – 36"  
Height: 84" – 120"  
Depth: 5-1/2" – 30"

- Matching specie interior is not available over 96" high. Natural Birch UV material will be used.
- When height changes, upper opening height changes. Lower opening height fixed at 56".
- 84" – 90" high has six shelves.
- 90-1/16" – 96" high has seven shelves.
- 96-1/16" – 108" high has eight shelves.
- 108-1/16" – 120" high has nine shelves.
- Separate 4" high toe platform available in all cabinet heights.
- Specify single or butt doors on custom size cabinets 24" wide.

84" High	90" High	96" High
UCD2484BD	UCD2490BD	UCD2496BD
UCD2784BD	UCD2790BD	UCD2796BD
UCD3084BD	UCD3090BD	UCD3096BD
UCD3384BD	UCD3390BD	UCD3396BD
UCD3684BD	UCD3690BD	UCD3696BD

**Options Key:** EXP = Exposed End(s) FL = Flush End(s) FUE = Flush Unexposed End(s) SS = Shaped Side PFD = Prep for False Door  
EXT = Extended Stile(s) FT = Flush Toe SBR = Shaped Bottom Rail LE = Leg Extension TSS = Toe Space Side OS = Omit Shelving  
NSH = No Shelf Holes WS = Solid Wood Shelves MI = Matching Interior DT = Dust Top NB = Natural Finished Bottom

### UCD/CSUCCS - Utility Cabinet Deep w/Center Stile

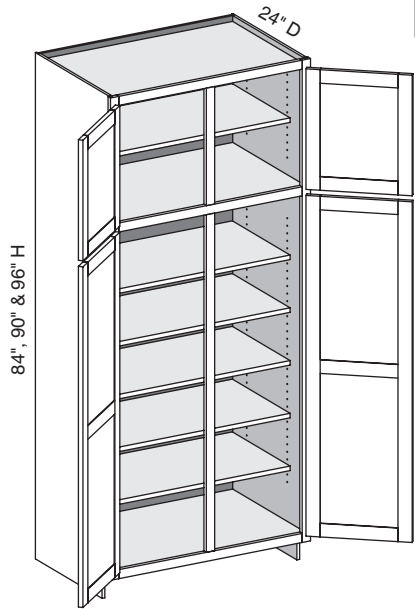

EXP	FL	FUE	SS	PFD	EXT	FT	SBR	LE	TSS	OS	NSH	WS	MI	DT	NB
✓	✓	✓	✓	✓	✓	✓	✓	✓	✓	✓	✓	✓	✓		

Custom Size Ranges  
 Width: 27" – 36"  
 Height: 84" – 120"  
 Depth: 5-1/2" – 30"

- Matching specie interior is not available over 96" high. Natural Birch UV material will be used.
- When height changes, upper opening height changes. Lower opening height fixed at 56".
- 84" – 90" high has six shelves.
- 90-1/16" – 96" high has seven shelves.
- 96-1/16" – 108" high has eight shelves.
- 108-1/16" – 120" high has nine shelves.
- Separate 4" high toe platform available in all cabinet heights.

84" High	90" High	96" High
UCD2784	UCD2790	UCD2796
UCD3084	UCD3090	UCD3096
UCD3384	UCD3390	UCD3396
UCD3684	UCD3690	UCD3696

### UCW/CSUCW - Utility Cabinet Wall Height Top Section

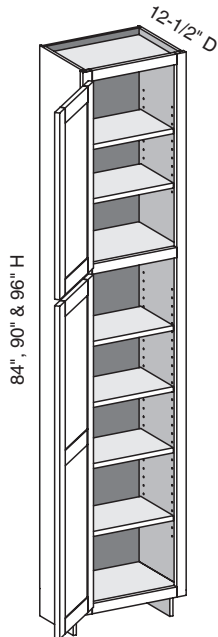

EXP	FL	FUE	SS	PFD	EXT	FT	SBR	LE	TSS	OS	NSH	WS	MI	DT	NB
✓	✓	✓		✓	✓	✓	✓	✓		✓	✓	✓	✓		

Custom Size Ranges  
 Width: 12" – 24"  
 Height: 84" – 120"  
 Depth: 5-1/2" – 30"

- Top section aligns with corresponding wall cabinet height as follows:  
 84" high – 30" wall cabinets.  
 90" high – 36" wall cabinets.  
 96" high – 42" wall cabinets.
- Matching specie interior is not available over 96" high. Natural Birch UV material will be used.
- When cabinet height changes, top opening height changes accordingly. Lower opening height is fixed at 48-1/2".
- 84" – 90" high has six shelves.
- 90-1/16" – 96" high has seven shelves.
- 96-1/16" – 108" high has eight shelves.
- 108-1/16" – 120" high has nine shelves.
- Separate 4" high toe platform available in all heights.
- Specify single or butt doors on custom size cabinets 24" wide.

84" High	90" High	96" High
UCW1584	UCW1590	UCW1596
UCW1884	UCW1890	UCW1896
UCW2184	UCW2190	UCW2196
UCW2484	UCW2490	UCW2496

Options Key: EXP = Exposed End(s) FL = Flush End(s) FUE = Flush Unexposed End(s) SS = Shaped Side PFD = Prep for False Door  
 EXT = Extended Stile(s) FT = Flush Toe SBR = Shaped Bottom Rail LE = Leg Extension TSS = Toe Space Side OS = Omit Shelving  
 NSH = No Shelf Holes WS = Solid Wood Shelves MI = Matching Interior DT = Dust Top NB = Natural Finished Bottom

**UCW/CSUCW - Utility Cabinet Wall Height Top Section w/Butt Doors**

EXP	FL	FUE	SS	PFD	EXT	FT	SBR	LE	TSS	OS	NSH	WS	MI	DT	NB
✓	✓	✓		✓	✓	✓	✓	✓		✓	✓	✓	✓		

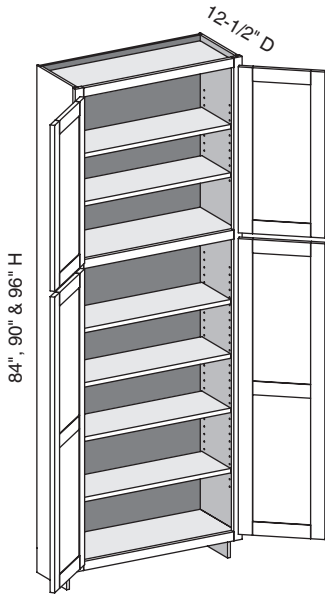

Custom Size Ranges  
Width: 24" – 36"  
Height: 84" – 120"  
Depth: 5-1/2" – 30"

- Top section aligns with corresponding wall cabinet height as follows:  
84" high – 30" wall cabinets.  
90" high – 36" wall cabinets.  
96" high – 42" wall cabinets.
- Matching specie interior is not available over 96" high. Natural Birch UV material will be used.
- When cabinet height changes, top opening height changes accordingly. Lower opening height is fixed at 48-1/2".
- 84" – 90" high has six shelves.
- 90-1/16" – 96" high has seven shelves.
- 96-1/16" – 108" high has eight shelves.
- 108-1/16" – 120" high has nine shelves
- Separate 4" high toe platform available in all cabinet heights.
- Specify single or butt doors on custom size cabinets 24" wide.

84" High	90" High	96" High
UCW2484BD	UCW2490BD	UCW2496BD
UCW2784BD	UCW2790BD	UCW2796BD
UCW3084BD	UCW3090BD	UCW3096BD
UCW3384BD	UCW3390BD	UCW3396BD
UCW3684BD	UCW3690BD	UCW3696BD

**UCW/CSUCWCS - Utility Cabinet Wall Height Top Section w/Center Stile**

EXP	FL	FUE	SS	PFD	EXT	FT	SBR	LE	TSS	OS	NSH	WS	MI	DT	NB
✓	✓	✓		✓	✓	✓	✓	✓		✓	✓	✓	✓		

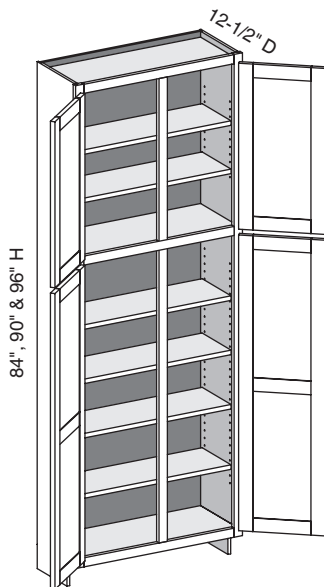

Custom Size Ranges  
Width: 27" – 36"  
Height: 84" – 120"  
Depth: 5-1/2" – 30"

- Top section aligns with corresponding wall cabinet height as follows:  
84" high – 30" wall cabinets.  
90" high – 36" wall cabinets.  
96" high – 42" wall cabinets.
- Matching specie interior is not available over 96" high. Natural Birch UV material will be used.
- When cabinet height changes, top opening height changes accordingly. Lower opening height is fixed at 48-1/2".
- 84" – 90" high has six shelves.
- 90-1/16" – 96" high has seven shelves.
- 96-1/16" – 108" high has eight shelves.
- 108-1/16" – 120" high has nine shelves.
- Separate 4" high toe platform available in all cabinet heights.
- Specify single or butt doors on custom size cabinets 24" wide.

84" High	90" High	96" High
UCW2784	UCW2790	UCW2796
UCW3084	UCW3090	UCW3096
UCW3384	UCW3390	UCW3396
UCW3684	UCW3690	UCW3696

**Options Key:** EXP = Exposed End(s) FL = Flush End(s) FUE = Flush Unexposed End(s) SS = Shaped Side PFD = Prep for False Door  
EXT = Extended Stile(s) FT = Flush Toe SBR = Shaped Bottom Rail LE = Leg Extension TSS = Toe Space Side OS = Omit Shelving  
NSH = No Shelf Holes WS = Solid Wood Shelves MI = Matching Interior DT = Dust Top NB = Natural Finished Bottom

### UCDW/CSUCW - Utility Cabinet Deep Wall Height Top Section

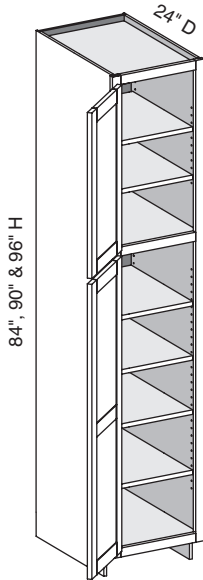

EXP	FL	FUE	SS	PFD	EXT	FT	SBR	LE	TSS	OS	NSH	WS	MI	DT	NB
✓	✓	✓	✓	✓	✓	✓	✓	✓	✓	✓	✓	✓	✓		

Custom Size Ranges  
 Width: 12" – 24"  
 Height: 84" – 120"  
 Depth: 5-1/2" – 30"

- Top section aligns with corresponding wall cabinet height as follows:  
 84" high – 30" wall cabinets.  
 90" high – 36" wall cabinets.  
 96" high – 42" wall cabinets.
- Matching specie interior is not available over 96" high. Natural Birch UV material will be used.
- When cabinet height changes, top opening height changes accordingly. Lower opening height is fixed at 48-1/2".
- 84" – 90" high has six shelves.
- 90-1/16" – 96" high has seven shelves.
- 96-1/16" – 108" high has eight shelves.
- 108-1/16" – 120" high has nine shelves.
- Separate 4" high toe platform available in all cabinet heights.
- Specify single or butt doors on custom size cabinets 24" wide.

84" High	90" High	96" High
UCDW1584	UCDW1590	UCDW1596
UCDW1884	UCDW1890	UCDW1896
UCDW2184	UCDW2190	UCDW2196
UCDW2484	UCDW2490	UCDW2496

7

### UCDW/CSUCW - Utility Cabinet Deep Wall Height Top Section w/Butt Doors

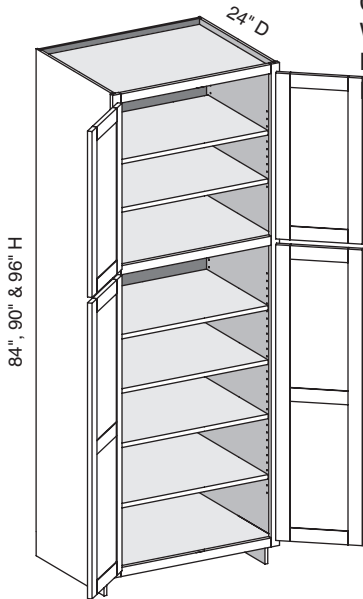

EXP	FL	FUE	SS	PFD	EXT	FT	SBR	LE	TSS	OS	NSH	WS	MI	DT	NB
✓	✓	✓	✓	✓	✓	✓	✓	✓	✓	✓	✓	✓	✓		

Custom Size Ranges  
 Width: 24" – 36"  
 Height: 84" – 120"  
 Depth: 5-1/2" – 30"

- Top section aligns with corresponding wall cabinet height as follows:  
 84" high – 30" wall cabinets.  
 90" high – 36" wall cabinets.  
 96" high – 42" wall cabinets.
- Matching specie interior is not available over 96" high. Natural Birch UV material will be used.
- When cabinet height changes, top opening height changes accordingly. Lower opening height is fixed at 48-1/2".
- 84" – 90" high has six shelves.
- 90-1/16" – 96" high has seven shelves.
- 96-1/16" – 108" high has eight shelves.
- 108-1/16" – 120" high has nine shelves.
- Separate 4" high toe platform available in all cabinet heights.
- Specify single or butt doors on custom size cabinets 24" wide.

84" High	90" High	96" High
UCDW2484BD	UCDW2490BD	UCDW2496BD
UCDW2784BD	UCDW2790BD	UCDW2796BD
UCDW3084BD	UCDW3090BD	UCDW3096BD
UCDW3384BD	UCDW3390BD	UCDW3396BD
UCDW3684BD	UCDW3690BD	UCDW3696BD

Tall Cabinets

Options Key: EXP = Exposed End(s) FL = Flush End(s) FUE = Flush Unexposed End(s) SS = Shaped Side PFD = Prep for False Door  
 EXT = Extended Stile(s) FT = Flush Toe SBR = Shaped Bottom Rail LE = Leg Extension TSS = Toe Space Side OS = Omit Shelving  
 NSH = No Shelf Holes WS = Solid Wood Shelves MI = Matching Interior DT = Dust Top NB = Natural Finished Bottom

**UCDW/CSUCWCS - Utility Cabinet Deep Wall Height Top Section w/Center Stile**

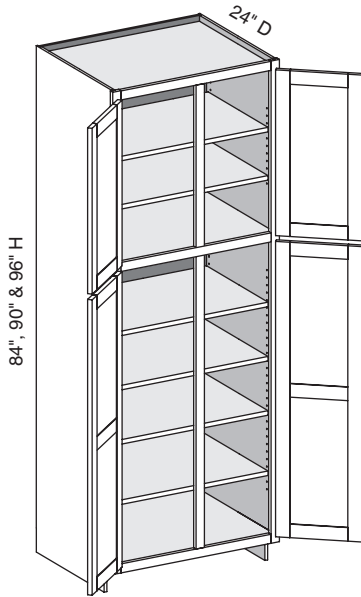

EXP	FL	FUE	SS	PFD	EXT	FT	SBR	LE	TSS	OS	NSH	WS	MI	DT	NB
✓	✓	✓	✓	✓	✓	✓	✓	✓	✓	✓	✓	✓	✓		

Custom Size Ranges  
Width: 27" – 36"  
Height: 84" – 120"  
Depth: 5-1/2" – 30"

- Top section aligns with corresponding wall cabinet height as follows:  
84" high – 30" wall cabinets.  
90" high – 36" wall cabinets.  
96" high – 42" wall cabinets.
- Matching specie interior is not available over 96" high.  
Natural Birch UV material will be used.
- When cabinet height changes, top opening height changes accordingly. Lower opening height is fixed at 48-1/2".
- 84" – 90" high has six shelves.
- 90-1/16" – 96" high has seven shelves.
- 96-1/16" – 108" high has eight shelves.
- 108-1/16" – 120" high has nine shelves.
- Separate 4" high toe platform available in all cabinet heights.

84" High	90" High	96" High
UCDW2784	UCDW2790	UCDW2796
UCDW3084	UCDW3090	UCDW3096
UCDW3384	UCDW3390	UCDW3396
UCDW3684	UCDW3690	UCDW3696

**UCR/CSUCR - Utility Cabinet Reverse**

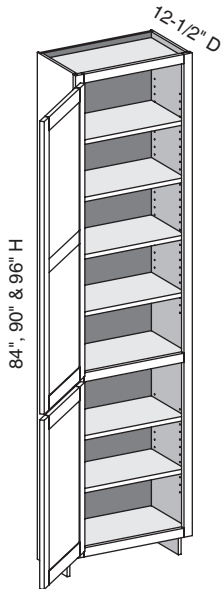

EXP	FL	FUE	SS	PFD	EXT	FT	SBR	LE	TSS	OS	NSH	WS	MI	DT	NB
✓	✓	✓		✓	✓	✓	✓	✓		✓	✓	✓	✓		

Custom Size Ranges  
Width: 12" – 24"  
Height: 84" – 120"  
Depth: 5-1/2" – 30"

- Matching specie interior is not available over 96" high.  
Natural Birch UV material will be used.
- When cabinet height changes, top opening height changes accordingly. Lower opening height is fixed at 27-1/2".
- 84" – 90" high has six shelves.
- 90-1/16" – 96" high has seven shelves.
- 96-1/16" – 108" high has eight shelves.
- 108-1/16" – 120" high has nine shelves.
- Separate 4" high toe platform available in all cabinet heights.

84" High	90" High	96" High
UCR1584	UCR1590	UCR1596
UCR1884	UCR1890	UCR1896
UCR2184	UCR2190	UCR2196
UCR2484	UCR2490	UCR2496

**Options Key:** EXP = Exposed End(s) FL = Flush End(s) FUE = Flush Unexposed End(s) SS = Shaped Side PFD = Prep for False Door  
EXT = Extended Stile(s) FT = Flush Toe SBR = Shaped Bottom Rail LE = Leg Extension TSS = Toe Space Side OS = Omit Shelving  
NSH = No Shelf Holes WS = Solid Wood Shelves MI = Matching Interior DT = Dust Top NB = Natural Finished Bottom



### UCR/CSUCR - Utility Cabinet Reverse w/Butt Doors

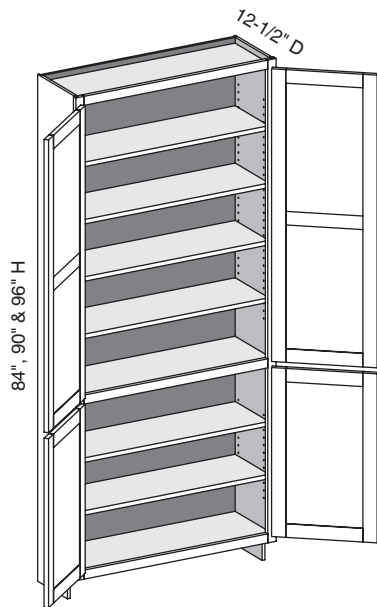

EXP	FL	FUE	SS	PFD	EXT	FT	SBR	LE	TSS	OS	NSH	WS	MI	DT	NB
✓	✓	✓		✓	✓	✓	✓	✓		✓	✓	✓	✓		

Custom Size Ranges  
 Width: 24" – 36"  
 Height: 84" – 120"  
 Depth: 5-1/2" – 30"

- Matching specie interior is not available over 96" high. Natural Birch UV material will be used.
- When cabinet height changes, upper opening height changes. Lower opening height is fixed at 27-1/2".
- 84" – 90" high has six shelves.
- 90-1/16" – 96" high has seven shelves.
- 96-1/16" – 108" high has eight shelves.
- 108-1/16" – 120" high has nine shelves.
- Separate 4" high toe platform available in all cabinet heights.
- Specify single or butt doors on custom size cabinets 24" wide.

84" High	90" High	96" High
UCR2484BD	UCR2490BD	UCR2496BD
UCR2784BD	UCR2790BD	UCR2796BD
UCR3084BD	UCR3090BD	UCR3096BD
UCR3384BD	UCR3390BD	UCR3396BD
UCR3684BD	UCR3690BD	UCR3696BD

### UCR/CSUCRCS - Utility Cabinet Reverse w/Center Stile

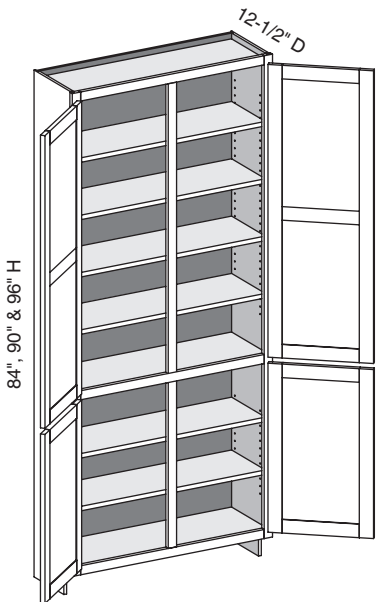

EXP	FL	FUE	SS	PFD	EXT	FT	SBR	LE	TSS	OS	NSH	WS	MI	DT	NB
✓	✓	✓		✓	✓	✓	✓	✓		✓	✓	✓	✓		

Custom Size Ranges  
 Width: 24" – 36"  
 Height: 84" – 120"  
 Depth: 5-1/2" – 30"

- Matching specie interior is not available over 96" high. Natural Birch UV material will be used.
- When cabinet height changes, top opening height changes accordingly. Lower opening height is fixed at 27-1/2".
- 84" – 90" high has six shelves.
- 90-1/16" – 96" high has seven shelves.
- 96-1/16" – 108" high has eight shelves.
- 108-1/16" – 120" high has nine shelves.
- Separate 4" high toe platform available in all cabinet heights.

84" High	90" High	96" High
UCR2784	UCR2790	UCR2796
UCR3084	UCR3090	UCR3096
UCR3384	UCR3390	UCR3396
UCR3684	UCR3690	UCR3696

**Options Key:** EXP = Exposed End(s) FL = Flush End(s) FUE = Flush Unexposed End(s) SS = Shaped Side PFD = Prep for False Door  
 EXT = Extended Stile(s) FT = Flush Toe SBR = Shaped Bottom Rail LE = Leg Extension TSS = Toe Space Side OS = Omit Shelving  
 NSH = No Shelf Holes WS = Solid Wood Shelves MI = Matching Interior DT = Dust Top NB = Natural Finished Bottom



**UCDR/CSUCR - Utility Cabinet Deep Reverse**

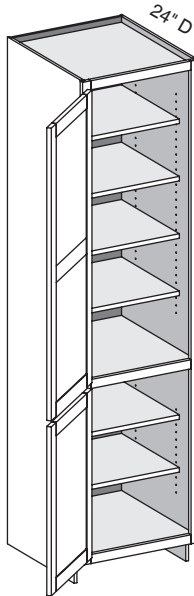

EXP	FL	FUE	SS	PFD	EXT	FT	SBR	LE	TSS	OS	NSH	WS	MI	DT	NB
✓	✓	✓	✓	✓	✓	✓	✓	✓	✓	✓	✓	✓	✓		

Custom Size Ranges  
Width: 12" – 24"  
Height: 84" – 120"  
Depth: 5-1/2" – 30"

- Matching specie interior is not available over 96" high. Natural Birch UV material will be used.
- When height changes, upper opening height changes. Lower opening height fixed at 27-1/2".
- 84" – 90" high has six shelves.
- 90-1/16" – 96" high has seven shelves.
- 96-1/16" – 108" high has eight shelves.
- 108-1/16" – 120" high has nine shelves.
- Separate 4" high toe platform available in all cabinet heights.
- Specify single or butt doors on custom size cabinets 24" wide.

84" High	90" High	96" High
UCDR1584	UCDR1590	UCDR1596
UCDR1884	UCDR1890	UCDR1896
UCDR2184	UCDR2190	UCDR2196
UCDR2484	UCDR2490	UCDR2496

**UCDR/CSUCR - Utility Cabinet Deep Reverse w/Butt Doors**

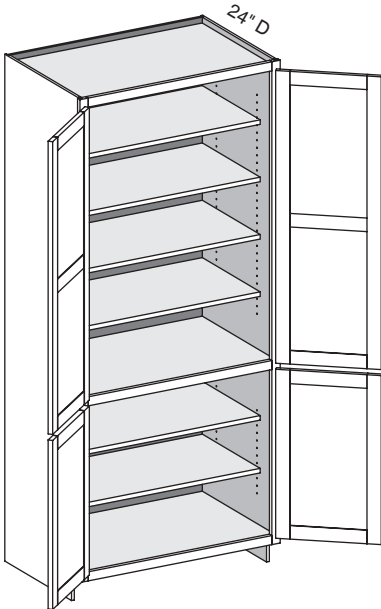

EXP	FL	FUE	SS	PFD	EXT	FT	SBR	LE	TSS	OS	NSH	WS	MI	DT	NB
✓	✓	✓	✓	✓	✓	✓	✓	✓	✓	✓	✓	✓	✓		

Custom Size Ranges  
Width: 24" – 36"  
Height: 84" – 120"  
Depth: 5-1/2" – 30"

- Matching specie interior is not available over 96" high. Natural Birch UV material will be used.
- When cabinet height changes, upper opening height changes. Lower opening height is fixed at 27-1/2".
- 84" – 90" high has six shelves.
- 90-1/16" – 96" high has seven shelves.
- 96-1/16" – 108" high has eight shelves.
- 108-1/16" – 120" high has nine shelves.
- Separate 4" high toe platform available in all cabinet heights.
- Specify single or butt doors on custom size cabinets 24" wide.

84" High	90" High	96" High
UCDR2484BD	UCDR2490BD	UCDR2496BD
UCDR2784BD	UCDR2790BD	UCDR2796BD
UCDR3084BD	UCDR3090BD	UCDR3096BD
UCDR3384BD	UCDR3390BD	UCDR3396BD
UCDR3684BD	UCDR3690BD	UCDR3696BD

**Options Key:** EXP = Exposed End(s) FL = Flush End(s) FUE = Flush Unexposed End(s) SS = Shaped Side PFD = Prep for False Door  
EXT = Extended Stile(s) FT = Flush Toe SBR = Shaped Bottom Rail LE = Leg Extension TSS = Toe Space Side OS = Omit Shelving  
NSH = No Shelf Holes WS = Solid Wood Shelves MI = Matching Interior DT = Dust Top NB = Natural Finished Bottom

### UCDR/CSUCRCS - Utility Cabinet Deep Reverse w/Center Stile

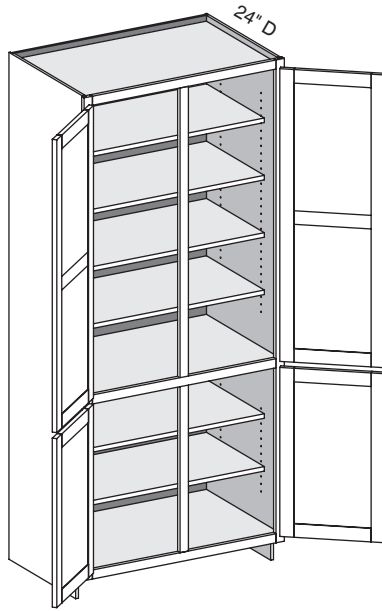

EXP	FL	FUE	SS	PFD	EXT	FT	SBR	LE	TSS	OS	NSH	WS	MI	DT	NB
✓	✓	✓	✓	✓	✓	✓	✓	✓	✓	✓	✓	✓	✓		

Custom Size Ranges  
 Width: 27" – 36"  
 Height: 84" – 120"  
 Depth: 5-1/2" – 30"

- Matching specie interior is not available over 96" high. Natural Birch UV material will be used.
- When height changes, upper opening height changes. Lower opening height fixed at 27-1/2".
- 84" – 90" high has six shelves.
- 90-1/16" – 96" high has seven shelves.
- 96-1/16" – 108" high has eight shelves.
- 108-1/16" – 120" high has nine shelves.
- Separate 4" high toe platform available in all cabinet heights.

84" High	90" High	96" High
UCDR2784	UCDR2790	UCDR2796
UCDR3084	UCDR3090	UCDR3096
UCDR3384	UCDR3390	UCDR3396
UCDR3684	UCDR3690	UCDR3696

### U2D/CSU2D - Utility Two Drawer

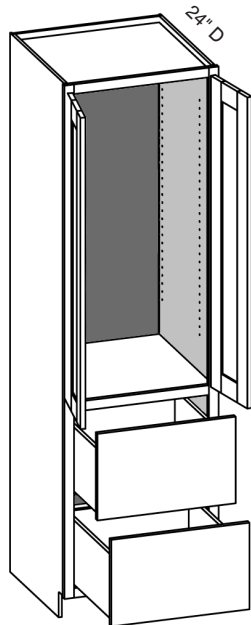

EXP	FL	FUE	SS	PFD	EXT	FT	SBR	LE	TSS	OS	NSH	WS	MI	DT	NB
✓	✓	✓	✓	✓	✓	✓	✓	✓	✓	✓	✓	✓	✓		

Custom Size Ranges  
 Single Door Width: 12" – 24"  
 Butt Door Width: 24" – 36"  
 Height: 84" – 96"  
 Depth: 12", 15", 18", 21", 24", 27", 30"

- When height changes, upper opening height changes.
- Lower drawer section aligns with 34-1/2" high base cabinets. Drawer front heights are equal.
- 84" – 90" high has four shelves.
- 90-1/16" – 96" high has five shelves.
- 96-1/16" – 108" high has six shelves.
- 108-1/16" 120" high has seven shelves.
- Specify single or butt doors on custom size cabinets 24" wide.

Single Door			Butt Doors		
84" High	90" High	96" High	84" High	90" High	96" High
U2D1884	U2D1890	U2D1896	U2D2484BD	U2D2490BD	U2D2496BD
U2D2184	U2D2190	U2D2196	U2D2784BD	U2D2790BD	U2D2796BD
U2D2484	U2D2490	U2D2496	U2D3084BD	U2D3090BD	U2D3096BD
			U2D3384BD	U2D3390BD	U2D3396BD
			U2D3684BD	U2D3690BD	U2D3696BD

**Options Key:** EXP = Exposed End(s) FL = Flush End(s) FUE = Flush Unexposed End(s) SS = Shaped Side PFD = Prep for False Door  
 EXT = Extended Stile(s) FT = Flush Toe SBR = Shaped Bottom Rail LE = Leg Extension TSS = Toe Space Side OS = Omit Shelving  
 NSH = No Shelf Holes WS = Solid Wood Shelves MI = Matching Interior DT = Dust Top NB = Natural Finished Bottom

**U3D/CSU3D - Utility Three Drawer**

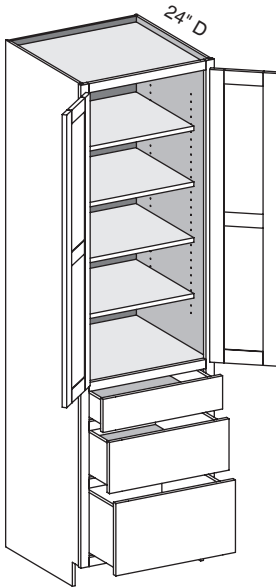

EXP	FL	FUE	SS	PFD	EXT	FT	SBR	LE	TSS	OS	NSH	WS	MI	DT	NB
✓	✓	✓	✓	✓	✓	✓	✓	✓	✓	✓	✓	✓	✓		

Custom Size Ranges  
 Single Door Width: 12" – 24"  
 Butt Door Width: 24" – 36"  
 Height: 84" – 120"  
 Depth: 12", 15", 18",  
 21", 24", 27", 30"

- Matching specie interior is not available over 96" high. Natural Birch UV material will be used.
- When height changes, upper opening height changes.
- Lower drawer section aligns with 34-1/2" high base cabinets.
- 84" – 90" high has four shelves.
- 90-1/16" – 96" high has five shelves.
- 96-1/16" – 108" high has eight shelves.
- 108-1/16" – 120" high has nine shelves.
- Separate 4" high toe platform available in all cabinet heights.
- Specify single or butt doors on custom size cabinets 24" wide.

Single Door			Butt Doors		
84" High	90" High	96" High	84" High	90" High	96" High
U3D1884	U3D1890	U3D1896	U3D2484BD	U3D2490BD	U3D2496BD
U3D2184	U3D2190	U3D2196			
U3D2484	U3D2490	U3D2496			

**UCDRRO/CSUCRRO - Utility Cabinet Deep Reverse Roll-Out**

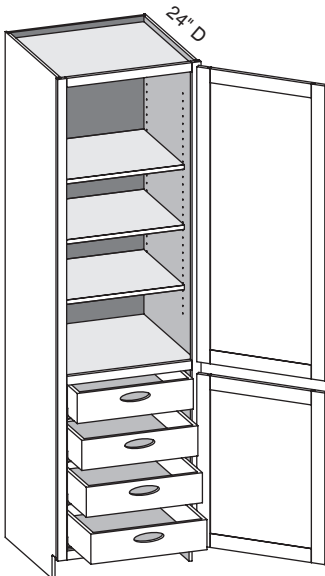

EXP	FL	FUE	SS	PFD	EXT	FT	SBR	LE	TSS	OS	NSH	WS	MI	DT	NB
✓	✓	✓	✓	✓	✓	✓	✓	✓	✓	✓	✓	✓			

Custom Size Ranges  
 Width: 12" – 24"  
 Height: 84" – 120"  
 Depth: 12", 15", 18",  
 21", 24", 27", 30"

- Units are configured with four 5" high drawer boxes. Interior panels are pre-drilled for drawer slide placement and installation.
- Roll-out drawers include hand pulls. Specify Standard, Circle or Ellipse (shown) pull.
- When height changes, upper opening height changes. Lower opening height fixed at 27-1/2".
- 84" – 90" high has four shelves.
- 90-1/16" – 96" high has five shelves.
- 96 1/16" – 108" high has six shelves.
- 108-1/16" – 120" has seven shelves.
- Separate 4" high toe platform available in all cabinet heights.
- Specify single or butt doors on custom size cabinets 24" wide.

84" High	90" High	96" High
UCDRRO1584	UCDRRO1590	UCDRRO1596
UCDRRO1884	UCDRRO1890	UCDRRO1896
UCDRRO2184	UCDRRO2190	UCDRRO2196
UCDRRO2484	UCDRRO2490	UCDRRO2496

**Options Key:** EXP = Exposed End(s) FL = Flush End(s) FUE = Flush Unexposed End(s) SS = Shaped Side PFD = Prep for False Door  
 EXT = Extended Stile(s) FT = Flush Toe SBR = Shaped Bottom Rail LE = Leg Extension TSS = Toe Space Side OS = Omit Shelving  
 NSH = No Shelf Holes WS = Solid Wood Shelves MI = Matching Interior DT = Dust Top NB = Natural Finished Bottom

### UCDRROI/CSUCRROI - Utility Cabinet Deep Reverse Roll-Out Inset

EXP	FL	FUE	SS	PFD	EXT	FT	SBR	LE	TSS	OS	NSH	WS	MI	DT	NB
✓	✓	✓	✓	✓	✓	✓	✓	✓	✓	✓	✓	✓			

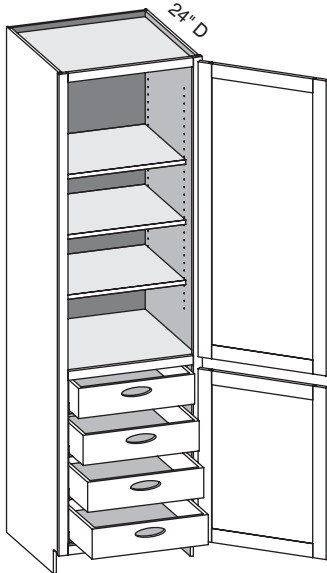

Custom Size Ranges  
 Width: 15" – 36"  
 Height: 84" – 120"  
 Depth: 12", 15", 18",  
 21", 24", 27", 30"

- Specifically designed for inset applications.
- Units are configured with four 5" high drawer boxes. Interior panels are pre-drilled for drawer slide placement and installation.
- Roll-out drawers include hand pulls. Specify Standard, Circle or Ellipse (shown) pull.
- When height changes, upper opening height changes. Lower opening height fixed at 27-1/2".
- 84" – 90" high has four shelves.
- 90-1/16" – 96" high has five shelves.
- 96 1/16" – 108" high has six shelves.
- 108-1/16" – 120" has seven shelves.
- Separate 4" high toe platform available in all cabinet heights.
- Specify single or butt doors on custom size cabinets 24" wide.

84" High	90" High	96" High
UCDRROI1584	UCDRROI1590	UCDRROI1596
UCDRROI1884	UCDRROI1890	UCDRROI1896
UCDRROI2184	UCDRROI2190	UCDRROI2196
UCDRROI2484	UCDRROI2490	UCDRROI2496

7

### UCDRRO/CSUCRRO - Utility Cabinet Deep Reverse Roll-Out w/Butt Doors

EXP	FL	FUE	SS	PFD	EXT	FT	SBR	LE	TSS	OS	NSH	WS	MI	DT	NB
✓	✓	✓	✓	✓	✓	✓	✓	✓	✓	✓	✓	✓			

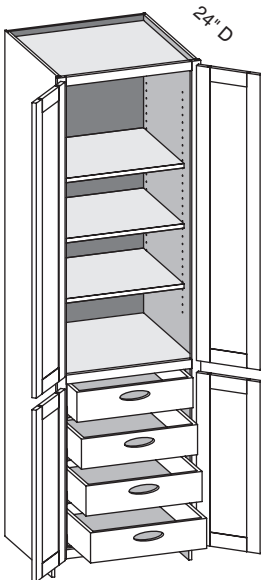

Custom Size Ranges  
 Width: 24" – 36"  
 Height: 84" – 120"  
 Depth: 12", 15", 18",  
 21", 24", 27", 30"

- Units are configured with four 5" high drawer boxes. Interior panels are pre-drilled for drawer slide placement and installation.
- Roll-out drawers include hand pulls. Specify Standard, Circle or Ellipse (shown) pull.
- When height changes, upper opening height changes. Lower opening height fixed at 27-1/2".
- 84" – 90" high has four shelves.
- 90-1/16" – 96" high has five shelves.
- 96 1/16" – 108" high has six shelves.
- 108-1/16" – 120" has seven shelves.
- Separate 4" high toe platform available in all cabinet heights.
- Specify single or butt doors on custom size cabinets 24" wide.

84" High	90" High	96" High
UCDRRO2484BD	UCDRRO2490BD	UCDRRO2496BD
UCDRRO2784BD	UCDRRO2790BD	UCDRRO2796BD
UCDRRO3084BD	UCDRRO3090BD	UCDRRO3096BD
UCDRRO3384BD	UCDRRO3390BD	UCDRRO3396BD
UCDRRO3684BD	UCDRRO3690BD	UCDRRO3696BD

Tall Cabinets

**Options Key:** EXP = Exposed End(s) FL = Flush End(s) FUE = Flush Unexposed End(s) SS = Shaped Side PFD = Prep for False Door  
 EXT = Extended Stile(s) FT = Flush Toe SBR = Shaped Bottom Rail LE = Leg Extension TSS = Toe Space Side OS = Omit Shelving  
 NSH = No Shelf Holes WS = Solid Wood Shelves MI = Matching Interior DT = Dust Top NB = Natural Finished Bottom

## UCDRROI/CSUCRROI - Utility Cabinet Deep Reverse Roll-Out Inset w/Butt Doors

EXP	FL	FUE	SS	PFD	EXT	FT	SBR	LE	TSS	OS	NSH	WS	MI	DT	NB
✓	✓	✓	✓	✓	✓	✓	✓	✓	✓	✓	✓	✓			

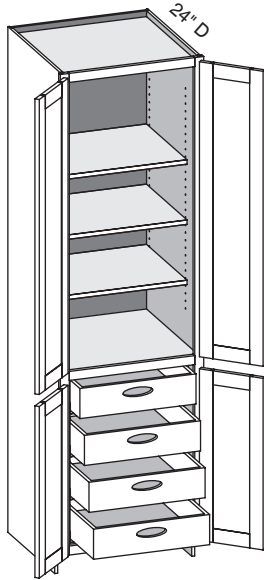

Custom Size Ranges  
 Width: 24" – 36"  
 Height: 84" – 120"  
 Depth: 12", 15", 18", 21", 24", 27", 30"

- Specifically designed for inset applications.
- Units are configured with four 5" high drawer boxes. Interior panels are pre-drilled for drawer slide placement and installation.
- Roll-out drawers include hand pulls. Specify Standard, Circle or Ellipse (shown) pull.
- When height changes, upper opening height changes. Lower opening height fixed at 27-1/2".
- 84" – 90" high has four shelves.
- 90-1/16" – 96" high has five shelves.
- 96 1/16" – 108" high has six shelves.
- 108-1/16" – 120" has seven shelves.
- Separate 4" high toe platform available in all cabinet heights.
- Specify single or butt doors on custom size cabinets 24" wide.

84" High	90" High	96" High
UCDRROI2484BD	UCDRROI2490BD	UCDRROI2496BD
UCDRROI2784BD	UCDRROI2790BD	UCDRROI2796BD
UCDRROI3084BD	UCDRROI3090BD	UCDRROI3096BD
UCDRROI3384BD	UCDRROI3390BD	UCDRROI3396BD
UCDRROI3684BD	UCDRROI3690BD	UCDRROI3696BD

## ODA/CSODA - Oven Double Opening Type A w/Butt Doors

EXP	FL	FUE	SS	PFD	EXT	FT	SBR	LE	TSS	OS	NSH	WS	MI	DT	NB
✓	✓	✓	✓	✓	✓	✓	✓	✓	✓	✓	✓	✓	✓		

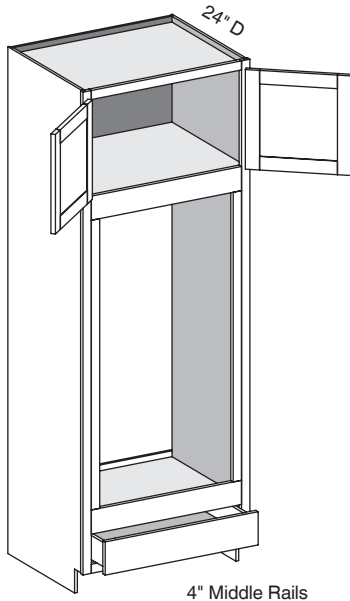

Custom Size Ranges  
 Width: 27" – 36"  
 Height: 84" – 120"  
 Depth: 24", 27", 30"

- Oven opening is 48" high, width is 6" less than cabinet width.
- Oven opening is trimmable up to 5" in height and 3" in width.
- Oven opening is 14-1/2" above the floor, trimmable to 12".
- Matching specie interior is not available over 96" high. Natural Birch UV material will be used.
- When height changes, upper opening height changes. Lower and middle opening heights fixed.
- 84" – 89-15/16" high has no shelves.
- 90" – 95-15/16" high has one shelf.
- 96" high has two shelves.
- 96-1/16" – 120" high has three shelves.
- Separate 4" high toe platform available in all cabinet heights.

84" High	90" High	96" High
ODA2784BD	ODA2790BD	ODA2796BD
ODA3084BD	ODA3090BD	ODA3096BD
ODA3384BD	ODA3390BD	ODA3396BD

**Options Key:** EXP = Exposed End(s) FL = Flush End(s) FUE = Flush Unexposed End(s) SS = Shaped Side PFD = Prep for False Door  
 EXT = Extended Stile(s) FT = Flush Toe SBR = Shaped Bottom Rail LE = Leg Extension TSS = Toe Space Side OS = Omit Shelving  
 NSH = No Shelf Holes WS = Solid Wood Shelves MI = Matching Interior DT = Dust Top NB = Natural Finished Bottom

### ODA/CSODACS - Oven Double Opening Type A w/Center Stile

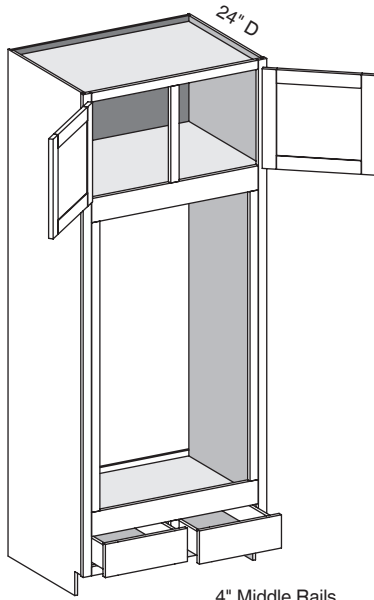

EXP	FL	FUE	SS	PFD	EXT	FT	SBR	LE	TSS	OS	NSH	WS	MI	DT	NB
✓	✓	✓	✓	✓	✓	✓	✓	✓	✓	✓	✓	✓	✓		

Custom Size Ranges  
 Width: 27" – 36"  
 Height: 84" – 120"  
 Depth: 24", 27", 30"

- Oven opening is 48" high, width is 6" less than cabinet width.
- Oven opening is trimmable up to 5" in height and 3" in width.
- Oven opening is 14-1/2" above the floor, trimmable to 12".
- Matching specie interior is not available over 96" high. Natural Birch UV material will be used.
- When height changes, upper opening height changes. Lower and middle opening heights fixed.
- 84" – 89-15/16" high has no shelves.
- 90" – 95-15/16" high has one shelf.
- 96" high has two shelves.
- 96-1/16" – 120" high has three shelves.
- Separate 4" high toe platform available in all cabinet heights.

84" High	90" High	96" High
ODA3084	ODA3090	ODA3096
ODA3384	ODA3390	ODA3396

### ODB/CSODB - Oven Double Opening Type B w/Butt Doors

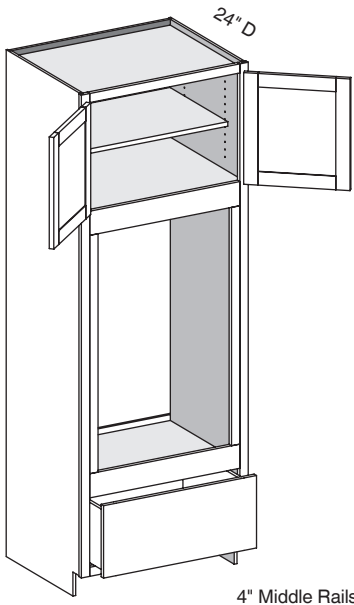

EXP	FL	FUE	SS	PFD	EXT	FT	SBR	LE	TSS	OS	NSH	WS	MI	DT	NB
✓	✓	✓	✓	✓	✓	✓	✓	✓	✓	✓	✓	✓	✓		

Custom Size Ranges  
 Width: 27" – 36"  
 Height: 84" – 120"  
 Depth: 24", 27", 30"

- Oven opening is 39-1/2" high, width is 6" less than cabinet width.
- Oven opening is trimmable up to 5" in height and 3" in width.
- Oven opening is 21" above the floor, trimmable to 18-1/2".
- Matching specie interior is not available over 96" high. Natural Birch UV material will be used.
- When height changes, upper opening height changes. Lower and middle opening heights fixed.
- 84" – 89-15/16" high has one shelf.
- 90" – 96" high has two shelves.
- 96-1/16" – 120" high has three shelves.
- Separate 4" high toe platform available in all cabinet heights.

84" High	90" High	96" High
ODB3084BD	ODB3090BD	ODB3096BD
ODB3384BD	ODB3390BD	ODB3396BD

Options Key: EXP = Exposed End(s) FL = Flush End(s) FUE = Flush Unexposed End(s) SS = Shaped Side PFD = Prep for False Door  
 EXT = Extended Stile(s) FT = Flush Toe SBR = Shaped Bottom Rail LE = Leg Extension TSS = Toe Space Side OS = Omit Shelving  
 NSH = No Shelf Holes WS = Solid Wood Shelves MI = Matching Interior DT = Dust Top NB = Natural Finished Bottom

**ODB/CSODBCS - Oven Double Opening Type B w/Center Stile**

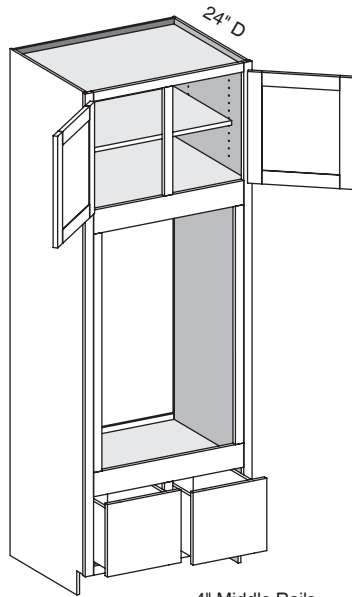

4" Middle Rails

EXP	FL	FUE	SS	PFD	EXT	FT	SBR	LE	TSS	OS	NSH	WS	MI	DT	NB
✓	✓	✓	✓	✓	✓	✓	✓	✓	✓	✓	✓	✓	✓		

Custom Size Ranges  
Width: 30" – 36"  
Height: 84" – 120"  
Depth: 24", 27", 30"

- Oven opening is 39-1/2" high, width is 6" less than cabinet width.
- Oven opening is trimmable up to 5" in height and 3" in width.
- Oven opening is 21" above the floor, trimmable to 18-1/2".
- Matching specie interior is not available over 96" high. Natural Birch UV material will be used.
- When height changes, upper opening height changes. Lower and middle opening heights fixed.
- 84" – 89-15/16" high has one shelf.
- 90" – 96" high has two shelves.
- 96-1/16" – 108" high has four shelves.
- 108-1/16" – 120" high has five shelves.
- Separate 4" high toe platform available in all cabinet heights.

84" High	90" High	96" High
ODB3084	ODB3090	ODB3096
ODB3384	ODB3390	ODB3396

**OS/CSOS - Oven Single Opening w/Butt Doors**

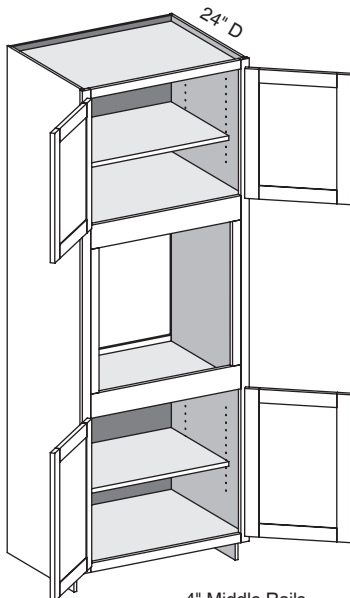

4" Middle Rails

EXP	FL	FUE	SS	PFD	EXT	FT	SBR	LE	TSS	OS	NSH	WS	MI	DT	NB
✓	✓	✓	✓	✓	✓	✓	✓	✓	✓	✓	✓	✓	✓		

Custom Size Ranges  
Width: 27" – 36"  
Height: 84" – 120"  
Depth: 24" – 30"

- Oven opening is 24" high, width is 6" less than cabinet width.
- Oven opening is trimmable up to 5" in height and 3" in width.
- Oven opening is 33-1/2" above the floor, trimmable to 31".
- Matching specie interior is not available over 96" high. Natural Birch UV material will be used.
- When height changes, upper opening height changes. Lower and middle opening heights fixed.
- Lower opening is fixed at 24".
- 84" – 89-15/16" high has two shelves.
- 90" – 96" high has three shelves.
- 96-1/16" – 108" high has four shelves.
- 108-1/16" – 120" high has five shelves.
- Separate 4" high toe platform available in all cabinet heights.

84" High	90" High	96" High
OS2784BD	OS2790BD	OS2796BD
OS3084BD	OS3090BD	OS3096BD
OS3384BD	OS3390BD	OS3396BD

**Options Key:** EXP = Exposed End(s) FL = Flush End(s) FUE = Flush Unexposed End(s) SS = Shaped Side PFD = Prep for False Door  
EXT = Extended Stile(s) FT = Flush Toe SBR = Shaped Bottom Rail LE = Leg Extension TSS = Toe Space Side OS = Omit Shelving  
NSH = No Shelf Holes WS = Solid Wood Shelves MI = Matching Interior DT = Dust Top NB = Natural Finished Bottom



### OS/CSOSCS - Oven Single Opening w/Center Stile

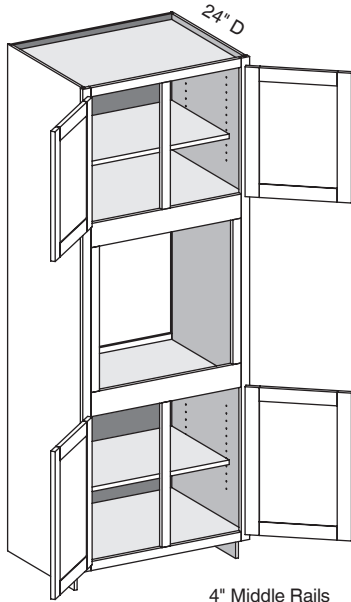

EXP	FL	FUE	SS	PFD	EXT	FT	SBR	LE	TSS	OS	NSH	WS	MI	DT	NB
✓	✓	✓	✓	✓	✓	✓	✓	✓	✓	✓	✓	✓	✓		

Custom Size Ranges  
 Width: 27" – 36"  
 Height: 84" – 120"  
 Depth: 24" – 30"

- Oven opening is 24" high, width is 6" less than cabinet width.
- Oven opening is trimmable up to 5" in height and 3" in width.
- Oven opening is 33-1/2" above the floor, trimmable to 31".
- Matching specie interior is not available over 96" high. Natural Birch UV material will be used.
- When height changes, upper opening height changes. Lower and middle opening heights fixed.
- Lower opening is fixed at 24".
- 84" – 89-15/16" high has two shelves.
- 90" – 96" high has three shelves.
- 96-1/16" – 108" high has four shelves.
- 108-1/16" – 120" high has five shelves.
- Separate 4" high toe platform available in all cabinet heights.

4" Middle Rails

84" High	90" High	96" High
OS2784	OS2790	OS2796
OS3084	OS3090	OS3096
OS3384	OS3390	OS3396

7

Tall Cabinets

### RTB/CSRTB - Refrigerator Tall Both Sides w/Butt Doors

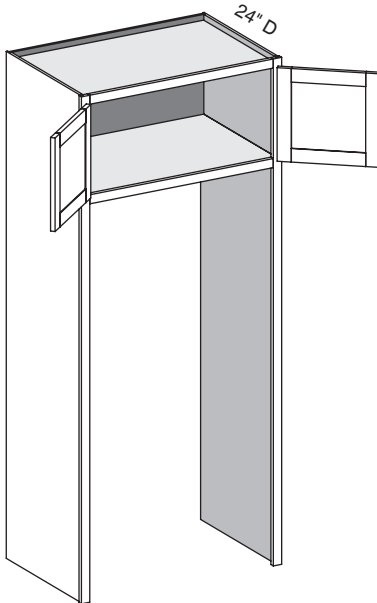

EXP	FL	FUE	SS	PFD	EXT	FT	SBR	LE	TSS	OS	NSH	WS	MI	DT	NB
✓	✓	✓		✓	✓					✓	✓	✓	✓		

Custom Size Ranges  
 Width: 30" – 36"  
 Height: 84" – 120"  
 Depth: 8" – 30"

- Middle numbers in the cabinet code refer to the height of the wall cabinet (example: RTB331284 has a 12" high upper cabinet).
- Matching specie interior is not available over 96" high. Natural Birch UV material will be used.
- When ordering custom size refrigerator cabinets specify top cabinet height.
- 21" – 24" high upper cabinets have one shelf.
- 24-1/16" – 27" high upper cabinet has two shelves.

84" High	90" High	96" High
RTB331284BD	RTB331890BD	RTB332496BD
RTB331584BD	RTB332190BD	RTB332796BD
RTB331884BD	RTB332490BD	RTB362496BD
RTB361284BD	RTB361890BD	RTB362796BD
RTB361584BD	RTB362190BD	
RTB361884BD	RTB362490BD	

Options Key: EXP = Exposed End(s) FL = Flush End(s) FUE = Flush Unexposed End(s) SS = Shaped Side PFD = Prep for False Door  
 EXT = Extended Stile(s) FT = Flush Toe SBR = Shaped Bottom Rail LE = Leg Extension TSS = Toe Space Side OS = Omit Shelving  
 NSH = No Shelf Holes WS = Solid Wood Shelves MI = Matching Interior DT = Dust Top NB = Natural Finished Bottom

**RTBHKXS/CSRTBHKXS - Refrigerator Tall Both w/HK-XS Lift System**

EXP	FL	FUE	SS	PFD	EXT	FT	SBR	LE	TSS	OS	NSH	WS	MI	DT	NB
✓	✓	✓		✓	✓					✓	✓	✓	✓		

Custom Size Ranges  
Width: 30" – 39"  
Height: 84" – 120"  
Depth: 24" – 30"

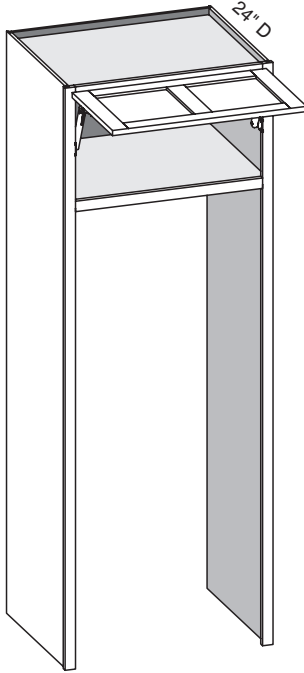

- Preconfigured units include HK-XS Series lift system hardware and Blum COMPACT hinges.
- Door weight and design determine the strength and quantity of lift mechanisms provided.
- Cabinet width 15" – 24" are single panel door designs. 24-1/16" – 36" are two panels side by side. Upcharges for 2 panel door applies.
- Rabbeted edge profiles and inset/prefit options are not available.
- Middle numbers in the cabinet code refer to the height of the wall cabinet (example: RTBHKXS331284 has a 12" high upper cabinet).
- Matching specie interior is not available over 96" high. Natural Birch UV material will be used.
- When ordering custom size refrigerator cabinets specify top cabinet height.
- 12" – 18" high upper cabinet has no shelves.
- 18-1/16" – 24" high upper cabinet has one shelf.

84" High	90" High	96" High
RTBHKXS331284	RTBHKXS331890	RTBHKXS332496
RTBHKXS331584	RTBHKXS332190	RTBHKXS362496
RTBHKXS331884	RTBHKXS332490	RTBHKXS392496
RTBHKXS361284	RTBHKXS361890	
RTBHKXS361584	RTBHKXS362190	
RTBHKXS361884	RTBHKXS362490	
RTBHKXS391284	RTBHKXS391890	
RTBHKXS391584	RTBHKXS392190	
RTBHKXS391884		

**Options Key:** EXP = Exposed End(s) FL = Flush End(s) FUE = Flush Unexposed End(s) SS = Shaped Side PFD = Prep for False Door  
EXT = Extended Stile(s) FT = Flush Toe SBR = Shaped Bottom Rail LE = Leg Extension TSS = Toe Space Side OS = Omit Shelving  
NSH = No Shelf Holes WS = Solid Wood Shelves MI = Matching Interior DT = Dust Top NB = Natural Finished Bottom

### RTB/CSRTBCS - Refrigerator Tall Both Sides w/Center Stile

EXP	FL	FUE	SS	PFD	EXT	FT	SBR	LE	TSS	OS	NSH	WS	MI	DT	NB
✓	✓	✓		✓	✓					✓	✓	✓	✓		

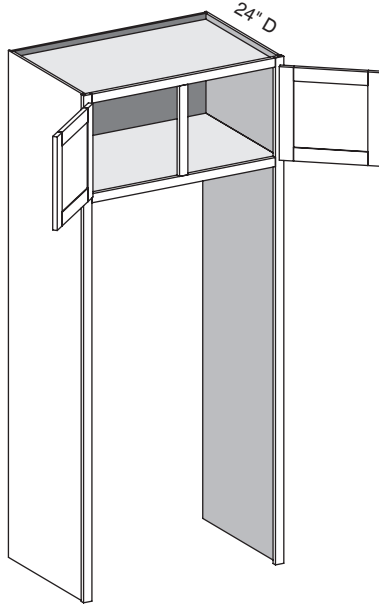

Custom Size Ranges  
 Width: 30" – 51"  
 Height: 84" – 120"  
 Depth: 8" – 30"

- Middle numbers in the cabinet code refer to the height of the wall cabinet (example: RTB331284 has a 12" high upper cabinet).
- Matching specie interior is not available over 96" high. Natural Birch UV material will be used.
- When ordering custom size refrigerator cabinets specify top cabinet height.
- 21" – 24" high upper cabinets have one shelf.
- 24-1/16" – 27" high upper cabinet has two shelves.

84" High	90" High	96" High
RTB331284	RTB331890	RTB332496
RTB331584	RTB332190	RTB332796
RTB331884	RTB332490	RTB362496
RTB361284	RTB361890	RTB362796
RTB361584	RTB362190	RTB392496
RTB361884	RTB362490	RTB392796
RTB391284	RTB391890	
RTB391584	RTB392190	
RTB391884	RTB392490	

7

Tall Cabinets

### RTL/CSRTL - Refrigerator Tall Left w/Butt Doors

EXP	FL	FUE	SS	PFD	EXT	FT	SBR	LE	TSS	OS	NSH	WS	MI	DT	NB
✓	✓	✓		✓	✓					✓	✓	✓	✓		

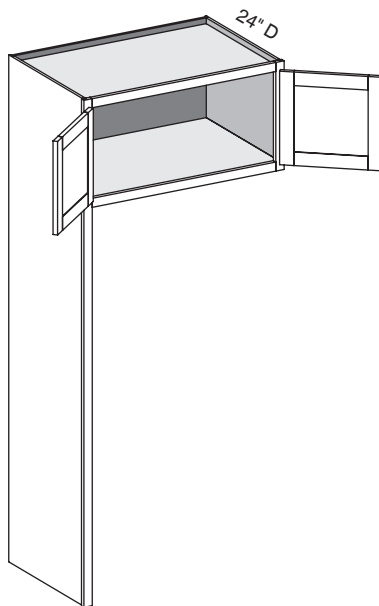

Custom Size Ranges  
 Width: 30" – 36"  
 Height: 84" – 120"  
 Depth: 8" – 30"

- Middle numbers in the cabinet code refer to the height of the wall cabinet (example: RTL331284 has a 12" high upper cabinet).
- Matching specie interior is not available over 96" high. Natural Birch UV material will be used.
- When ordering custom size refrigerator cabinets specify top cabinet height.
- 21" – 24" high upper cabinets have one shelf.
- 24-1/16" – 27" high upper cabinet has two shelves.

84" High	90" High	96" High
RTL331284BD	RTL331890BD	RTL332496BD
RTL331584BD	RTL332190BD	RTL332796BD
RTL331884BD	RTL332490BD	RTL362496BD
RTL361284BD	RTL361890BD	RTL362796BD
RTL361584BD	RTL362190BD	
RTL361884BD	RTL362490BD	

**Options Key:** EXP = Exposed End(s) FL = Flush End(s) FUE = Flush Unexposed End(s) SS = Shaped Side PFD = Prep for False Door  
 EXT = Extended Stile(s) FT = Flush Toe SBR = Shaped Bottom Rail LE = Leg Extension TSS = Toe Space Side OS = Omit Shelving  
 NSH = No Shelf Holes WS = Solid Wood Shelves MI = Matching Interior DT = Dust Top NB = Natural Finished Bottom

**RTLHKXS/CSRTLHKXS - Refrigerator Tall Left w/HK-XS Lift System**

EXP	FL	FUE	SS	PFD	EXT	FT	SBR	LE	TSS	OS	NSH	WS	MI	DT	NB
✓	✓	✓		✓	✓					✓	✓	✓	✓		

Custom Size Ranges  
Width: 30" – 39"  
Height: 84" – 120"  
Depth: 24" – 30"

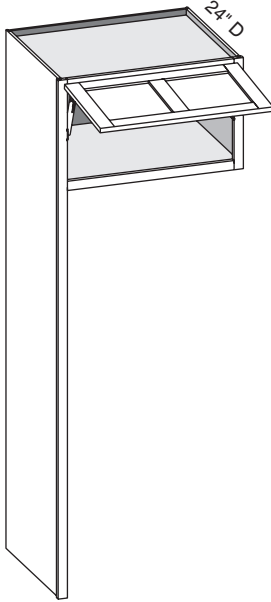

- Preconfigured units include HK-XS Series lift system hardware and Blum COMPACT hinges.
- Door weight and design determine the strength and quantity of lift mechanisms provided.
- Cabinet width 15" – 24" are single panel door designs. 24-1/16" – 36" are two panels side by side. Upcharges for 2 panel door applies.
- Rabbeted edge profiles and inset/prefit options are not available.
- Middle numbers in the cabinet code refer to the height of the wall cabinet (example: RTLHKXS331284 has a 12" high upper cabinet).
- Matching specie interior is not available over 96" high. Natural Birch UV material will be used.
- When ordering custom size refrigerator cabinets specify top cabinet height.
- 12" – 18" high upper cabinet has no shelves.
- 18-1/16" – 24" high upper cabinet has one shelf.

84" High	90" High	96" High
RTLHKXS331284	RTLHKXS331890	RTLHKXS332496
RTLHKXS331584	RTLHKXS332190	RTLHKXS362496
RTLHKXS331884	RTLHKXS332490	RTLHKXS392496
RTLHKXS361284	RTLHKXS361890	
RTLHKXS361584	RTLHKXS362190	
RTLHKXS361884	RTLHKXS362490	
RTLHKXS391284	RTLHKXS391890	
RTLHKXS391584	RTLHKXS392190	
RTLHKXS391884	RTLHKXS392490	

**Options Key:** EXP = Exposed End(s) FL = Flush End(s) FUE = Flush Unexposed End(s) SS = Shaped Side PFD = Prep for False Door  
EXT = Extended Stile(s) FT = Flush Toe SBR = Shaped Bottom Rail LE = Leg Extension TSS = Toe Space Side OS = Omit Shelving  
NSH = No Shelf Holes WS = Solid Wood Shelves MI = Matching Interior DT = Dust Top NB = Natural Finished Bottom

### RTL/CSRTLCS - Refrigerator Tall Left w/Center Stile

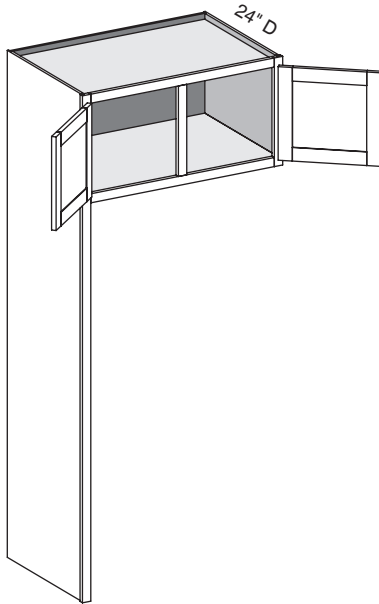

EXP	FL	FUE	SS	PFD	EXT	FT	SBR	LE	TSS	OS	NSH	WS	MI	DT	NB
✓	✓	✓		✓	✓					✓	✓	✓	✓		

Custom Size Ranges  
 Width: 30" – 51"  
 Height: 84" – 120"  
 Depth: 8" – 30"

- Middle numbers in the cabinet code refer to the height of the wall cabinet (example: RTB331284 has a 12" high upper cabinet).
- Matching specie interior is not available over 96" high. Natural Birch UV material will be used.
- When ordering custom size refrigerator cabinets specify top cabinet height.
- 21" – 24" high upper cabinets have one shelf.
- 24-1/16" – 27" high upper cabinet has two shelves.

84" High	90" High	96" High
RTL331284	RTL331890	RTL332496
RTL331584	RTL332190	RTL332796
RTL331884	RTL332490	RTL362496
RTL361284	RTL361890	RTL362796
RTL361584	RTL362190	RTL392496
RTL361884	RTL362490	RTL392796
RTL391284	RTL391890	
RTL391584	RTL392190	
RTL391884	RTL392490	

7

Tall Cabinets

### RTR/CSRTR - Refrigerator Tall Right w/Butt Doors

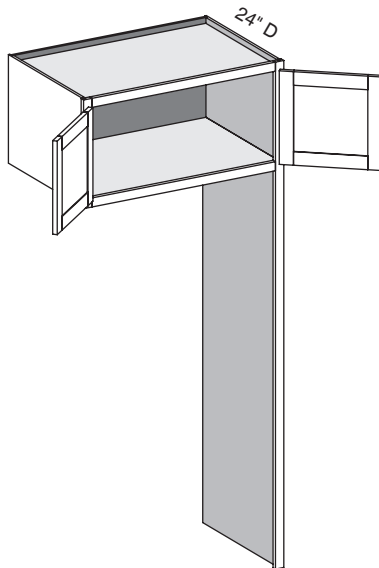

EXP	FL	FUE	SS	PFD	EXT	FT	SBR	LE	TSS	OS	NSH	WS	MI	DT	NB
✓	✓	✓		✓	✓					✓	✓	✓	✓		

Custom Size Ranges  
 Width: 30" – 36"  
 Height: 84" – 120"  
 Depth: 8" – 30"

- Middle numbers in the cabinet code refer to the height of the wall cabinet (example: RTB331284 has a 12" high upper cabinet).
- Matching specie interior is not available over 96" high. Natural Birch UV material will be used.
- When ordering custom size refrigerator cabinets specify top cabinet height.
- 21" – 24" high upper cabinets have one shelf.
- 24-1/16" – 27" high upper cabinet has two shelves.

84" High	90" High	96" High
RTR331284BD	RTR331890BD	RTR332496BD
RTR331584BD	RTR332190BD	RTR332796BD
RTR331884BD	RTR332490BD	RTR362496BD
RTR361284BD	RTR361890BD	RTR362796BD
RTR361584BD	RTR362190BD	
RTR361884BD	RTR362490BD	

**Options Key:** EXP = Exposed End(s) FL = Flush End(s) FUE = Flush Unexposed End(s) SS = Shaped Side PFD = Prep for False Door  
 EXT = Extended Stile(s) FT = Flush Toe SBR = Shaped Bottom Rail LE = Leg Extension TSS = Toe Space Side OS = Omit Shelving  
 NSH = No Shelf Holes WS = Solid Wood Shelves MI = Matching Interior DT = Dust Top NB = Natural Finished Bottom

**RTRHKXS/CSRTRHKXS - Refrigerator Tall Right w/HK-XS Lift System**

EXP	FL	FUE	SS	PFD	EXT	FT	SBR	LE	TSS	OS	NSH	WS	MI	DT	NB
✓	✓	✓		✓	✓					✓	✓	✓	✓		

Custom Size Ranges  
Width: 30" – 39"  
Height: 84" – 120"  
Depth: 24" – 30"

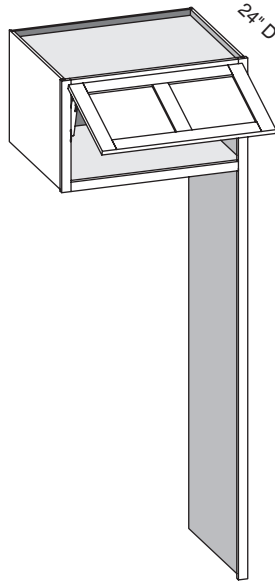

- Preconfigured units include HK-XS Series lift system hardware and Blum COMPACT hinges.
- Door weight and design determine the strength and quantity of lift mechanisms provided.
- Cabinet width 15" – 24" are single panel door designs. 24-1/16" – 36" are two panels side by side. Upcharges for 2 panel door applies.
- Rabbeted edge profiles and inset/prefit options are not available.
- Middle numbers in the cabinet code refer to the height of the wall cabinet (example: RTRHKXS331284 has a 12" high upper cabinet).
- Matching specie interior is not available over 96" high. Natural Birch UV material will be used.
- When ordering custom size refrigerator cabinets specify top cabinet height.
- 12" – 18" high upper cabinet has no shelves.
- 18-1/16" – 24" high upper cabinet has one shelf.

84" High	90" High	96" High
RTRHKXS331284	RTRHKXS331890	RTRHKXS332496
RTRHKXS331584	RTRHKXS332190	RTRHKXS362496
RTRHKXS331884	RTRHKXS332490	RTRHKXS392496
RTRHKXS361284	RTRHKXS361890	
RTRHKXS361584	RTRHKXS362190	
RTRHKXS361884	RTRHKXS362490	
RTRHKXS391284	RTRHKXS391890	
RTRHKXS391584	RTRHKXS392190	
RTRHKXS391884	RTRHKXS392490	

**Options Key:** EXP = Exposed End(s) FL = Flush End(s) FUE = Flush Unexposed End(s) SS = Shaped Side PFD = Prep for False Door  
EXT = Extended Stile(s) FT = Flush Toe SBR = Shaped Bottom Rail LE = Leg Extension TSS = Toe Space Side OS = Omit Shelving  
NSH = No Shelf Holes WS = Solid Wood Shelves MI = Matching Interior DT = Dust Top NB = Natural Finished Bottom

### RTR/CSRTRCS - Refrigerator Tall Right w/Center Stile

EXP	FL	FUE	SS	PFD	EXT	FT	SBR	LE	TSS	OS	NSH	WS	MI	DT	NB
✓	✓	✓		✓	✓					✓	✓	✓	✓		

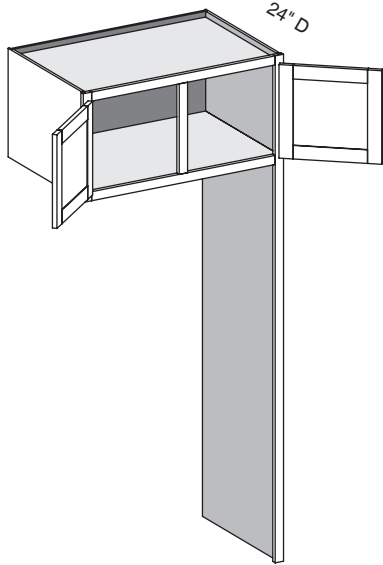

Custom Size Ranges  
 Width: 30" – 51"  
 Height: 84" – 120"  
 Depth: 8" – 30"

- Middle numbers in the cabinet code refer to the height of the wall cabinet (example: RTB331284 has a 12" high upper cabinet).
- Matching specie interior is not available over 96" high. Natural Birch UV material will be used.
- When ordering custom size refrigerator cabinets specify top cabinet height.
- 21" – 24" high upper cabinets have one shelf.
- 24-1/16" – 27" high upper cabinet has two shelves.

84" High	90" High	96" High
RTR331284	RTR331890	RTR332496
RTR331584	RTR332190	RTR332796
RTR331884	RTR332490	RTR362496
RTR361284	RTR361890	RTR362796
RTR361584	RTR362190	RTR392496
RTR361884	RTR362490	RTR392796
RTR391284	RTR391890	
RTR391584	RTR392190	
RTR391884	RTR392490	

7

### TCH/CSTCH - Tall Corner Hutch w/Butt Doors

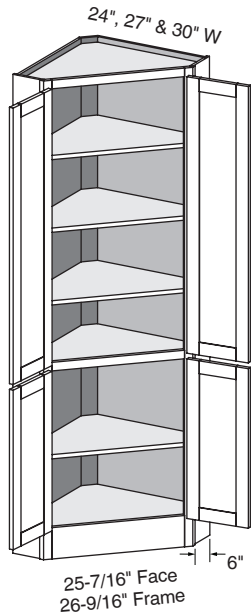

EXP	FL	FUE	SS	PFD	EXT	FT	SBR	LE	TSS	OS	NSH	WS	MI	DT	NB
✓	✓					STD	✓			✓	✓		✓		

Custom Size Ranges  
 Width: 24", 27", 30"  
 Height: 84" – 96"  
 Depth: 24", 27", 30"

- Lower section aligns with 34-1/2" high base cabinets.
- When height changes, upper opening height changes. Lower opening height fixed at 27-1/2".

84" High	
TCH2484BD	TCH3084BD
TCH2784BD	

Tall Cabinets

**Options Key:** EXP = Exposed End(s) FL = Flush End(s) FUE = Flush Unexposed End(s) SS = Shaped Side PFD = Prep for False Door  
 EXT = Extended Stile(s) FT = Flush Toe SBR = Shaped Bottom Rail LE = Leg Extension TSS = Toe Space Side OS = Omit Shelving  
 NSH = No Shelf Holes WS = Solid Wood Shelves MI = Matching Interior DT = Dust Top NB = Natural Finished Bottom



**CSCO - Case Only**

EXP	FL	FUE	SS	PFD	EXT	FT	SBR	LE	TSS	OS	NSH	WS	MI	DT	NB
✓	✓	✓	✓	✓		✓							✓		

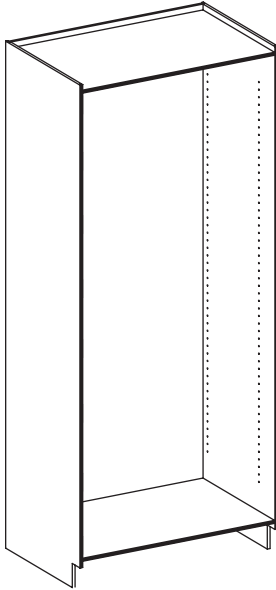

Custom Size Ranges  
Width: 12" – 48"  
Height: 10" – 120"  
Depth: 5-1/2" – 30"

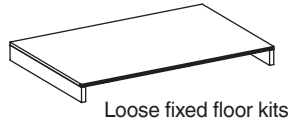

Loose fixed floor kits

- Use Conestoga's online ordering system, ConNex or Conestoga order entry for pricing.
- Customizable cabinet case for custom base and tall applications.
- No front frame included – case only. Order custom size front frame, shelves, doors, drawer fronts and drawer boxes separately.
- Sides are machined with shelf holes.
- Loose fixed floor kits are sized to fit between sides. Plywood cleats included to mount floors as needed behind front frame openings. Floors include pre-inserted splines. Specify quantity of fixed floor kits per cabinet.
- Matching specie interior is not available over 96" high. Natural Birch UV material will be used.
- Custom quantities of fixed floor kits are available. Specify the quantity per cabinet.
- 12" – 18" high has no shelves.
- 18-1/16" – 24" high has one shelf.
- 24-1/16" – 36" high has two shelves.
- 36-1/16" – 48" high has three shelves.
- 48-1/16" – 59-15/16" high has four shelves.
- 60" – 72-15/16" high has five shelves.
- 73" – 84-15/16" high has six shelves.
- 85" – 90-15/16" high has seven shelves.
- 91" – 96-15/16" high has eight shelves.
- 97" – 108-15/16" high has nine shelves.
- 109" – 120" high has ten shelves.

**CSCONH - Case Only No Shelf Holes**

EXP	FL	FUE	SS	PFD	EXT	FT	SBR	LE	TSS	OS	NSH	WS	MI	DT	NB
✓	✓	✓	✓	✓		✓					STD		✓		

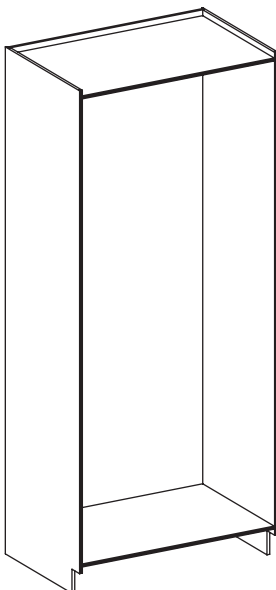

Custom Size Ranges  
Width: 12" – 48"  
Height: 10" – 120"  
Depth: 5-1/2" – 30"

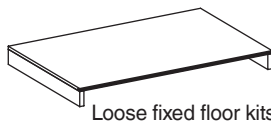

Loose fixed floor kits

- Use Conestoga's online ordering system, ConNex or Conestoga order entry for pricing.
- Customizable cabinet case for custom base and tall applications.
- No front frame included – case only. Order custom size front frame, doors, drawer fronts and drawer boxes separately.
- Loose fixed floor kits are sized to fit between sides. Plywood cleats included to mount floors as needed behind front frame openings. Floors include pre-inserted splines. Specify quantity of fixed floor kits per cabinet.
- Matching specie interior is not available over 96" high. Natural Birch UV material will be used.

**Options Key:** EXP = Exposed End(s) FL = Flush End(s) FUE = Flush Unexposed End(s) SS = Shaped Side PFD = Prep for False Door  
EXT = Extended Stile(s) FT = Flush Toe SBR = Shaped Bottom Rail LE = Leg Extension TSS = Toe Space Side OS = Omit Shelving  
NSH = No Shelf Holes WS = Solid Wood Shelves MI = Matching Interior DT = Dust Top NB = Natural Finished Bottom