



Quest

Specifications Guide / Valid thru November 2024

Please Note: Items are subject to change without prior notice. This spec book is missing some updated information, so to stay up to date with product specifications and modification options please use our digital spec book which can be found at <https://ezpricing.fabuwood.com/specbook>

New! Interactive Index

Specbook Updates	III	ADA Cabinets	18
Construction Specifications	IV	ADA Cabinets	18
Limited 5-Year Warranty	VI	Installed Accessories	20
Door Styles	VII	Storage Accessories	22
Sales Tools	VIII	Waste Solutions	22
Modifications	X	Base Accessories	23
Loose Parts	XII	Base & Wall Accessories	26
Shelving	XIII	Wall Accessories	27
Wall Cabinets	1	Sink Accessories	28
12", 15" & 18" High Wall Cabinets	1	Drawer Accessories	29
24" High & 24" Deep Wall Cabinets	2	Vanity Accessories	30
30" High Wall Cabinets	3	Cabinet Accessories	32
36" High Wall Cabinets	6	Fillers & Valance	32
42" High Wall Cabinets	8	Moldings (8')	33
Specialty Wall Cabinets	10	Panels	35
Base Cabinets	11	Paint & Touch Up Kits	36
Full Height Door Base Cabinets	11	Hafele Lighting	37
Base Cabinets	12	Under-Cabinet Lighting	37
Tall Cabinets	16	Height Alignment Guide	39
Tall Pantry Cabinets	16		
Vanity Cabinets	17		
Vanities	17		

Specbook Updates

- **New! Sales Tools:**
 - » Hafele LED Tabletop Display Board [pg. VIII](#)
 - » 2024 Style Guide Brochure [pg. X](#)
- **New! Cabinet Accessories:**
 - » UKBPO-B15 BLUM: Utensil Knife Block Pull-Out for 15" Base Full-Height Door Cabinet [pg. 25](#)
 - » Sink Accessory: UNDER SINK MAT is now available [pg. 28](#)
- **New! Expanded Size Offering for Dishwasher End Panel:**
 - » DWR1-1/2 Dishwasher End Panel [pg. 35](#)
- **Additional modifications! Updates & Pricing [pg. XI](#)**
 - » New modification: CHOOSE-INTERIOR
- **Updates in the Hafele Lighting Program [pg. 37:](#)**
 - » Pricing Reduction for Hafele LED Lighting
 - » Two new lighting options added for additional design options:
 - » LED 2-1/4" PUCK: Surface-Mount Puck Lighting, 2-1/4" diameter with decorative housing
 - » LED CAB INT 48" STRIP: 48" Trimmable Lighting Strip

Reminder: Be sure to include the Power supply starter kit(s) per number of zones and any additional Lighting switches as needed.
- **Height Alignment Guide [pg. 41](#)**

Construction Specifications

Quest Doors and Drawer Fronts:

The 5 piece Quest traditional overlay door has an MDF recessed center panel captured in a ¾" solid frame and is complimented with 5-piece matching drawer front.

Hinges:

Compact Blumotion (#38N355B.06) soft-close mechanism integrated in concealed six-way adjustable hinges.

Drawers:

The Quest line includes a ⅝" thick solid wood dovetail drawer box with a ⅜" plywood bottom. Tandem plus Blumotion (#554H5330B01) 80% extension concealed drawer runners.

Shelving:

15mm (⅝") thick select veneered plywood with matching wood edge-banding is used on all wall and base cabinetry where applicable. The adjustable shelves are supported by plastic self locking shelf clip.

Cabinet Sides, Backs, Tops and Bottoms:

½" thick veneered plywood with natural finished interiors. The backs are stapled and screwed into place for additional support.

Face Frame:

¾" x 1½" solid wood stiles and rails jointed with glue and dowels. Back of face frames are grooved to accept side panels.

Toe Kick:

¾" x 4½" select unfinished plywood* toe kick is added to each assembled cabinet. Additional 8-foot lengths of ¼" toe kicks are available in matching colors to our cabinetry.

Panel Beams:

2½" x ½" plywood* panel beam is fastened into a dovetail groove at the top of each base cabinet to ensure a straight fully integrated side, and for use of support and mounting of a countertop.

** May come in finish other than natural ply, this does not denigrate the quality of material or structure of the cabinet.*

Construction Specifications

- 1 Solid wood door and drawer front frames are mortise and tenon.
- 2 Door and drawer fronts are standard overlay.
- 3 Compact Blumotion (#38N355B.06) soft-close mechanism integrated in concealed six-way adjustable hinges.
- 4 5/8" solid wood dovetail drawer with 3/8" plywood bottom. Tandem plus Blumotion (#554H5330B01) 80% extension concealed drawer runners.
- 5 2 1/2" interior drawer height.
- 6 3/4" x 1 1/2" solid wood face frame.
- 7 1/2" select veneered plywood back with a natural finished interior.
- 8 1/2" unfinished plywood side panels grooved into face frame.
- 9 15mm (5/8") select veneered plywood adjustable shelving with matching wood veneer edge banding.
- 10 Base and tall cabinets are constructed with 3/4" x 4 1/2" plywood toe kick. Additional 8-foot lengths of 1/4" toe kicks are available in matching colors to our cabinetry.
- 11 2 1/2" x 1/2" plywood* panel beams dovetailed into the side panels for strength and stability.
- 12 Base cabinet has 11 7/8" deep shelf.
- 13 When placing an order, need to select exposed sides; Right, Left or Both. A 1/4" select medium-density fiberboard panel will be applied to the selected side(s), and the side will be near flush finished.
- 14 Rubber bumpers for door and drawer fronts.
- 15 Adjustable shelf clips.

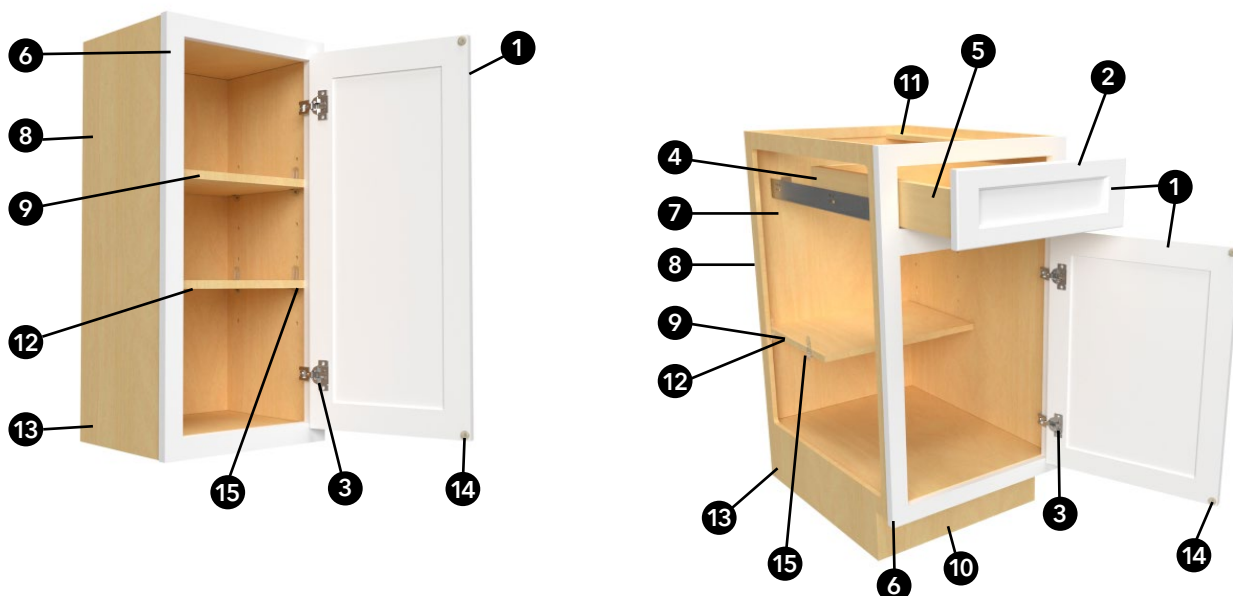

* May come in finish other than natural ply, this does not denigrate the quality of material or structure of the cabinet.

Limited 5-Year Warranty

COVERAGE OF WARRANTY

Fabuwood Cabinetry Corp. ("Fabuwood") is pleased to provide the following limited warranty to the first residential purchaser on all cabinets sold in the United States and Canada by an authorized Fabuwood dealer. This warranty does not cover cabinets sold or shipped outside of the United States and Canada. A First Residential Purchaser ("First Residential Purchaser") is a person who purchases and installs the cabinets in a dwelling that is owned and used by that person as a primary or secondary home, or, in the case of a developer or builder, this limited warranty may be assigned to the initial purchaser who uses the dwelling as a primary or secondary home. This warranty, however, is not transferable to subsequent owners of the home. This limited warranty is subject to all limitations, exclusions, disclaimers and procedures set forth herein.

LIMITED LIFETIME WARRANTY (Only on Allure, Illume, Value Premium, and Quest series cabinets): Fabuwood warrants to the First Residential Purchaser that all cabinets purchased from Fabuwood will be free from all unnatural defects in material and workmanship in accordance with Fabuwood's Quality Standards under normal residential use as long as the First Residential Purchaser owns the home in which such cabinets are installed.

EXCLUSIONS

THIS WARRANTY SUPERSEDES ANY AND ALL PREVIOUS WARRANTIES BY FABUWOOD AND CONSTITUTES THE EXCLUSIVE REMEDY AGAINST FABUWOOD FOR ALL DEFECTS, DAMAGES AND WORKMANSHIP. THERE ARE NO IMPLIED WARRANTIES EXTENDING BEYOND THE TERMS OF THIS WARRANTY. TO THE MAXIMUM EXTENT PERMITTED BY APPLICABLE LAW, FABUWOOD SHALL NOT BE LIABLE FOR ANY INDIRECT, SPECIAL, PUNITIVE, INCIDENTAL OR CONSEQUENTIAL COSTS, EXPENSES OR DAMAGES (INCLUDING LOST PROFITS), EVEN IF THIS LIMITED LIFETIME WARRANTY IS DEEMED TO HAVE FAILED OF ITS ESSENTIAL PURPOSE. SOME STATES DO NOT ALLOW THE EXCLUSION OR LIMITATION OF INCIDENTAL OR CONSEQUENTIAL DAMAGES, SO THE ABOVE LIMITATION OR EXCLUSION MAY NOT APPLY TO YOU. THIS WARRANTY GIVES YOU SPECIFIC LEGAL RIGHTS, AND YOU MAY ALSO HAVE OTHER RIGHTS, WHICH VARY FROM STATE TO STATE. IT IS POSSIBLE THAT ONE OR MORE OF THE LIMITATIONS AND EXCLUSIONS IN THIS WARRANTY MAY NOT APPLY TO YOU. THE LIMITED LIFETIME WARRANTY ON ALLURE, ILLUME, VALUE PREMIUM AND QUEST SERIES CABINETS APPLIES ONLY TO PRODUCTS PURCHASED ON OR AFTER OCTOBER 1, 2024. VALUE PREMIUM & QUEST SERIES CABINETS PURCHASED PRIOR TO OCTOBER 1, 2024, AND ALLURE & ILLUME SERIES CABINETS PURCHASED BEFORE JANUARY 26, 2023, ARE NOT INCLUDED IN THE LIMITED LIFETIME WARRANTY AND ARE SUBJECT TO FABUWOOD'S LIMITED 5-YEAR WARRANTY.

LIMITATIONS

This warranty shall become void if the cabinets, cabinetwork, drawer slides or hinges are modified from its original form, improperly installed or damaged prior to or during the installation, or used in any way other than for residential purposes. This warranty covers only parts and materials of the cabinets as supplied by Fabuwood. This warranty does not cover any products used or installed in connection with cabinets, such as gas or electric appliances, countertops, or plumbing fixtures. It also does not cover Blum hinges or any other third-party manufactured accessories or enhancements.

This warranty does not apply to products installed in locations that do not maintain year-round environmental controls. This warranty shall not apply to damages caused by transportation, storage, dirt, chemicals, exposure to moisture, humidity or excessive heat or cold, nor does it cover the effects arising from normal wear and tear, misuse, neglect, accidents, alterations, improper use or failure to maintain properly, house settling, or acts of God. No installer, retailer, distributor, agent or employee of Fabuwood has the authority to alter the obligations or limitations in this warranty.

QUALITY STANDARDS

This warranty covers all damages and unnatural defects that are deemed as such under the Fabuwood Quality Standards. The Fabuwood Quality Standards, which will be provided to you by your Fabuwood dealer upon request, should be reviewed at the time a claim for warranty service is being considered. Fabuwood reserves the right to modify or change the Fabuwood Quality Standards at any time without notice.

DISCLAIMERS

The following is a brief recap of some of the characteristics of the wood and finishes on the cabinets you are about to purchase. Please read them carefully. If some of these characteristics concern you, please choose something else. We bring these characteristics to your attention so you will realize that Fabuwood will not be held responsible for these variations in your cabinetry. It is important to note that wood products claimed as defective are most often the result of

atmospheric conditions such as excess moisture and humidity. Fabuwood strongly recommends testing the intended location of the products for such conditions prior to installation.

WOOD AND COLOR VARIATIONS: Wood is a product of nature, and since no two trees are alike, cabinets may vary in color, texture and grain. Wood characteristics naturally occurring such as variations in color, grain, mineral streaks, pinholes and knots are not considered defects. Color variations in cabinets are also a natural occurrence due to species, age, character of cabinets, and exposure to UV light, smoke, certain household cleaners, sunlight, extreme temperatures, and other environmental conditions. For these reasons, new and/or replacement cabinets may not match display samples and/or existing cabinets. This may result in overall color variations and is not considered a defect.

WOOD DOORS, DRAWER FRONTS, AND FACE FRAMES: Wood by nature will undergo expansion and contraction movements over the years as it compensates and adjusts to ever changing atmospheric humidity and temperature conditions. It is very common for center panels on doors to shrink, expand or move during these changes. Typically, the panel will return to its normal position within a year once it has adjusted to seasonal changes. It is for these same reasons that it is very common for doors to warp during these periods. Doors that are warped up to 1/4" are not considered defective. [Note: It is advisable to check if the door was properly installed, since doors that appear warped are very often the result of improper installation.] Painted doors, drawer fronts, and face frames may eventually have visible cracking around the joint areas, and cabinet colors may darken or lighten over time. These variations are considered to be the nature of the material in relation to their environmental exposure and are not covered under this Limited Lifetime Warranty.

PAINTED FINISHES: Plywood is a non-porous, smooth grained wood. Additionally, wood by nature undergoes periods of expansion and contraction while it adjusts to atmospheric conditions mentioned above. As such, finish stress lines may become visible on painted cabinets especially at the joints. Any such occurrence is not considered a defect.

GLAZED FINISHES: A glazed finish by character is an uneven finish. Some edges and profiles will be larger than others and glazing may vary cabinet to cabinet, door to drawer and item to item. This may result in overall color, texture, and finish variations but these are not considered defects.

WARRANTY PERFORMANCE

If a defect does occur within the terms and conditions of this warranty such defective part will be repaired or replaced by Fabuwood at its sole discretion. Fabuwood will not provide or pay for the cost of removal of defective product, transportation of defective, repaired or replaced product or installation of repaired or replaced product. If it is not commercially feasible to repair or replace a defective product, we may refund the original price paid by you for the defective product or provide a credit towards a similar type of product sold by us. Fabuwood will not be responsible for any shipping damages to the defective, replaced or repaired product. If defective item has been discontinued or is not available at the time, Fabuwood reserves the right to replace the item with the most similar item available in Fabuwood's inventory at that time. Fabuwood reserves the right to alter design, specifications and material without obligation to make similar changes to products previously manufactured. Fabuwood cannot guarantee that the finish of any replacement will exactly match the finish and appearance of the defective item due to the natural ageing process of the wood and finishes of the cabinets. Fabuwood may require at its discretion that the customer submit a clear photo, or that a company representative inspect the item being claimed before honoring this warranty.

CLAIMS

For a warranty claim made by the First Residential Purchaser to be considered, please contact the original Fabuwood-authorized dealer, who must file the claim through the Fabuwood EZ pricing system. In the event that the original dealer cannot be identified, or they have closed down, the warranty claim must be emailed to customerservice@fabuwood.com. The email should explain the issue and include pictures showing the claimed defects. Feel free to call +1 201-432-6555 ext. 1 for assistance.

NOTE

Please do not send back any items to Fabuwood prior to receiving proper Replacement Material Authorization ("RMA") from Warranty Support. Fabuwood takes no responsibility on any items sent back to Fabuwood without proper RMA.

Last Modified October 1, 2024: Change to include Value Premium, and Quest series cabinets under the Limited Lifetime Warranty. Previously Modified January 26, 2023: Change of the warranty on Allure and Illume series cabinets from a Limited 5-year Warranty to the Limited Lifetime Warranty.

Door Styles

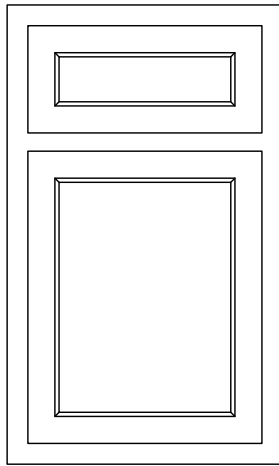

METRO

COLOR	FINISH
Frost	Paint
Mist*	Stain
Java*	Stain

- Traditional overlay door
- Rails are solid wood 3/4" thick and 2" wide
- Constructed with mortise and tenon joints
- MDF center panel captured into solid wood rails 6mm thick
- 5-piece recessed panel drawer front matches door edge design
- Door & drawer stiles and rails are 3/4" thick

* **FINISH DISCLAIMER:**

Due to the nature of wood and the complex finishing processes used to generate stained finishes, there may be variations in color which are considered normal.

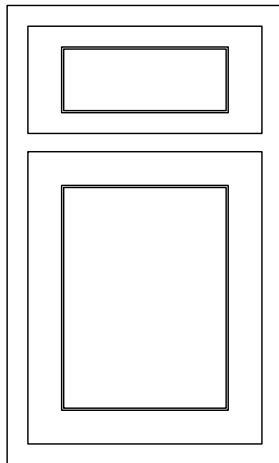

DISCOVERY

COLOR	FINISH
Frost	Paint

- Traditional overlay door
- Rails are solid wood 3/4" thick and 2 1/4" wide
- Constructed with mortise and tenon joints
- MDF center panel is 5mm thick
- 5-piece recessed panel drawer front matches door edge design

Pricing Note: Sales Tools are NET pricing; virtual multiplier applies to these items. Final price listed on Quote/Order will reflect the virtual multiplier.

Sales Tools

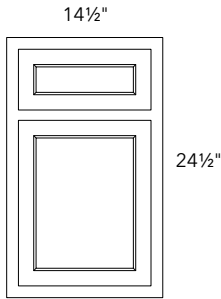

DOOR SAMPLES WITH DRAWER FRONT

ITEM	DESCRIPTION
SDMF	METRO FROST
SDMM	METRO MIST
SDMJ	METRO JAVA
SDDF	DISCOVERY FROST

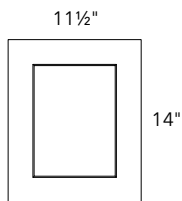

SMALL DOOR SAMPLES

ITEM	DESCRIPTION
SDMF-2	METRO FROST
SDMM-2	METRO MIST
SDMJ-2	METRO JAVA
SDDF-2	DISCOVERY FROST

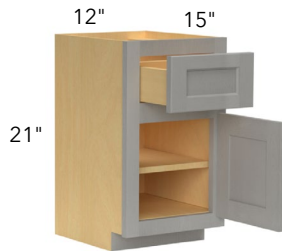

MINI BASE SAMPLE

ITEM	DESCRIPTION
MM MBS	BASE SAMPLE 12"W X 21"H X 15"D

- Available in Allure Galaxy Frost and Quest Metro Mist finish only.
- Cabinet exposed right side comes pre-finished with a near-flush finished end.



MOLDING CHAIN

ITEM	DESCRIPTION
MLK-QUEST	COMPLETE CHAIN OF QUEST MOLDINGS



NEW!

TABLETOP DISPLAY BOARD

ITEM	DESCRIPTION
LED TABLETOP DISPLAY	HAFELE LED TABLETOP DISPLAY BOARD

- Tabletop Display Boards provide dealers with a simple way of showing off Hafele LED Lighting & the components that Fabuwood includes in the starter kit.
- Includes two boards: one LED light board and one switch board with Starter Kit items (Driver, Port, WLS Light Switch)
 - » Light Board: 10-1/2" x 16-1/2"
 - » Switch Board: 16" x 23"

Pricing Note: Sales Tools are NET pricing; virtual multiplier applies to these items. Final price listed on Quote/Order will reflect the virtual multiplier.

Sales Tools



SELLING CENTER

ITEM	DESCRIPTION
DEALER SELLING CENTER	FABUWOOD SELLING CENTER
ACRYLIC LOGO 38X8	FABUWOOD ACRYLIC LOGO DISPLAY SIGN 38"X8"

Fabuwood Selling Center Display comes with:

- three (3) Base Cabinets, 12"W x 16"D
- FSC B12 include the following finishes: Illume Catalina Bianco Gloss, Allure Galaxy Nickel, & Quest Discovery Frost
- Full set of Large Sample Doors
- One of each molding chain for Allure, Quest
- Includes one Box set each of Color Blocks and Designer Collection Color Blocks
- Digital Brochure Keychains (Pack of 25)
- Pack of 25 Style Guide Brochures
- Acrylic Logo Sign included and available for separate purchase



Fabuwood Logo Sign:

- Now available as a stand-alone item for endless display options. Hang our sign amongst a gallery wall of Fabuwood Sample Doors, or pair with a Fabuwood vignette to create a unique Selling Center tailored to your individual showroom style.
- Acrylic sign predrilled with decorative chrome plated standoffs included.

SAMPLE DOOR STAND

ITEM	DESCRIPTION
SAMPLE DOOR STAND	SAMPLE DOOR DISPLAY STAND



Pricing Note: Sales Tools are NET pricing; virtual multiplier applies to these items. Final price listed on Quote/Order will reflect the virtual multiplier.

Sales Tools



COLOR BLOCKS

ITEM	DESCRIPTION
COLOR BLOCK	BOX OF COLOR BLOCKS



SAMPLE PACKAGES

ITEM	DESCRIPTION
SMALL SAMPLE PACKAGE	SMALL SAMPLE PACKAGE
DEALER PACKAGE	LITERATURE AND ACCESSORIES

Small Sample Package:

- Full Set of Small Sample Doors (door is 11-1/2" x 14"H)

Dealer Package:

- Full set of Large Sample Doors with Allure & Illume Signature colors (Includes Door & Drawer Front)
- One of each molding chain for Allure and Quest
- Full set of Color Blocks including Allure Signature, Allure Designer, & Illume Signature colors
- Digital Brochure Keychains (Pack of 25)
- Style Guide Brochure (Pack of 25)



DIGITAL BROCHURE

ITEM	DESCRIPTION
DIGITAL BROCHURE QR	QR CODE KEY RING

- Pack of 25 Key Rings



STYLE GUIDE

ITEM	DESCRIPTION
NEW! SG24	STYLE GUIDE BROCHURE 2024 (25PK)

- 72 pages, 8" x 8"
- Fabuwood's Style Guide showcases an extensive range of customizations and design possibilities. Featuring hoods, vanities, door styles, color collections, and more, it offers everything needed to create unique and personalized spaces

STYLE GUIDE BROCHURE 2023 (SG23) is still available for purchase in EZPO. Limited quantities available while supplies last.

Pricing Note: Sales Tools are NET pricing; virtual multiplier applies to these items. Final price listed on Quote/Order will reflect the virtual multiplier.

Modifications

CUT ITEMS

ITEM	DESCRIPTION
CUT-BASE	Reduce depth of base cabinet (min. depth 12")
CUT-DBASE	Reduce depth of drawer base cabinet (min. depth 12")
CUT-SBASE	Reduce depth of sink base cabinet (no min.)
CUT-WALL	Reduce depth of wall cabinet (no min.)
CUT-TALL	Reduce depth of tall cabinet (no min.)
CUT-DOOR	Cut out center panel of door for glass insert (per door, glass not included)
CUT-COLUMN	Reduce depth of column (specify depth)
CUT-BASE HEIGHT	Reduce height of base cabinet by cutting off top drawer (total base height: 28")
CUT-TK	Reduce toe kick height (no min.)
CUT-PANEL	Cut down a panel to any size
CUT-ROD	Reduce depth of rollout drawer (specify depth of cabinet)
CUT-KD30	Reduce depth of knee drawer cabinet

PIPE CHASE

ITEM	DESCRIPTION
CHASE-BASE	Make chase in base cabinet
CHASE-DBASE	Make chase in drawer base cabinet
CHASE-WALL	Make chase in wall cabinet
CHASE-TALL	Make chase in tall cabinet
CHASE-CORNER	Make chase in corner cabinet (WDC, WPC & ERB only)

Must supply a drawing for all chase modifications.

CUSTOMIZATIONS

ITEM	DESCRIPTION
CREATE-RETURN WALL*	Create a return wall filler up to 6"W x 15"D x 42"H (materials incl.)
CREATE-RETURN TALL*	Create a return tall filler up to 6"W x 30"D x 96"H (materials incl.)
CREATE-COLUMN BASE*	Create a 3" column up to 30"D by 34½"H
CREATE-COLUMN TALL*	Create an oversized column
CREATE-COLUMN WALL*	Create a 3" column up to 15"D x 42"H
HAMPER	Install door mounted pull out wood hamper in cabinet (cabinet not incl.)

* *Email orders@fabuwood.com for quote*

MODIFICATIONS

ITEM	DESCRIPTION
REMOVE-DRAWER	Remove cabinet drawer to create false drawer front
CLOSE-BLIND	Close open section of a blind wall or base cabinet

Sales Tools

MODIFICATIONS CONT.

ITEM	DESCRIPTION
ATTACH-TK	Attach toe kick on wall cabinet
RECESS-TK	Recess toe kick of base cabinet (must supply a drawing)
EDGE-BAND	Additional edge banding (price per linear foot)
PEN-CABINET	Create a peninsula cabinet from 2 cabinets (cabinets not incl.)
INCREASE-BASE	Increase depth on base cabinet
INCREASE-WALL	Increase depth on wall cabinet
INCREASE-TALL	Increase depth on tall cabinet
MATCH-INTERIOR	Stain interior of cabinet to match exterior
NEW! CHOOSE-INTERIOR	Finish interior of cabinet with selected paint or stain
CREATE- SQ BOTTOM	Square bottom shelf for wall open end to enable light rail molding
FLUSH-WALL BOTTOM	Flush the bottom of a wall cabinet
FLUSH-TOE KICK	Flush toe kick of base cabinet to face frame (sides not finished)
FULL-DOORS	Create full height door base cabinet from 2 cabinets (cabinets not incl.)
FILL HINGE-SEAM	Fills hinge holes with touch-up, seam will still be visible**
CLOSE FRONT-OC	Close front of base microwave, base oven, tall oven, or microwave cabinet
CREATE-BMC	Create base microwave cabinet from drawer base
CREATE-BOC	Create base oven cabinet from base cabinet
INSERT BROOM DIVIDER	Insert broom divider in tall pantry cabinet
INSERT DIVIDER	Insert vertical divider in a standard wall or base cabinet
INVERT FRAME-BASE	Invert door and drawer of base cabinet
INVERT FRAME-TALL	Invert frame and doors on tall pantry
REMOVE FLOOR	Remove bottom panel of cabinet
TK DRAWER	Install drawer into toekick of cabinet

* Email orders@fabuwood.com for quote

** Hinges are removed; doors will still be included and are packaged inside the cabinet

NOTE: Increased depth of Rollout drawers are by custom request only and are not included in INCREASE-BASE, INCREASE-TALL, and INCREASE-WALL modifications. Custom quote required.

UPGRADES

ITEM	DESCRIPTION
INSTALL-ACCES	Install any accessory in a cabinet (accessories not incl.)

* Email orders@fabuwood.com for quote

Loose Parts

LOOSE PARTS

ITEM	DESCRIPTION
SK BASE	Skin for base cabinet with adhesion
SK MC	Skin for microwave wall cabinet with adhesion
SK TALL	Skin for tall cabinet with adhesion
SK W30	Skin for 30" high wall cabinet with adhesion
SK W36	Skin for 36" high wall cabinet with adhesion
SK W42	Skin for 42" high wall cabinet with adhesion
STEM BUMPER	Individual Stem Bumper

**Moisture Resistant MDF will have visible green core*

Many more modifications available- please contact your customer service rep.

RESTRICTOR CLIPS

ITEM	DESCRIPTION
BLUM-COMPACT RES CLIP 10PK	PACK OF 10 BLUM-COMPACT ANGLE RESTRICTION CLIP
BLUM-LBS RES CLIP 2PK	PACK OF 2 BLUM LSB ANGLE RESTRICTION CLIP

- Compact Angle Restrictor Clip:**
 - BLUM Angle Restriction Clip for COMPACT BLUMOTION and COMPACT CLIP hinges.
 - Reduces swing from 110-deg to 86-deg
 - One clip required per every two hinges. For a 30" high door, use 1 clip. For 36" to 42" high Door, use 2 clips.
 - *Installation Tip:* Remove the door from the cabinet prior to installing the angle restriction clip. Insert the clip into the back of the cup hinge arm while it is in a 'closed' position.
- LSB Angle Restrictor Clip:**
 - BLUM Angle Restriction Clip for Lazy Susan 170-deg CLIP-ON Hinges
 - Reduces door LSB swing from 170-deg to 130-deg .
 - Easy to install, the LSB 170-deg angle restrictor clip snaps on to the projection point of the hinge.



BLUM-COMPACT RES CLIP



BLUM-LBS RES CLIP



STEM BUMPER

Shelving

LOOSE SHELVES

ITEM	DESCRIPTION
VS-B09	Value Shelf B09
VS-B12	Value Shelf for B12
VS-B15	Value Shelf for B15
VS-B18	Value Shelf for B18
VS-B21	Value Shelf for B21
VS-B24	Value Shelf for B24
VS-B27	Value Shelf for B27
VS-B30	Value Shelf for B30
VS-B33	Value Shelf for B33
VS-B36	Value Shelf for B36
VS-B39	Value Shelf for B39
VS-B42	Value Shelf for B42
VS-BRA24	Value Shelf for BRA-24
VS-LSB36	Value Shelf for Lazy Susan Base 36
VS-W09	Value Shelf for W09
VS-W12	Value Shelf for W12
VS-W15	Value Shelf for W15
VS-W18	Value Shelf for W18
VS-W21	Value Shelf for W21
VS-W24	Value Shelf for W24
VS-W2424D	Value Shelf for W24 24" Deep
VS-W27	Value Shelf for W27
VS-W30	Value Shelf for W30
VS-W3024D	Value Shelf for W3024 Deep
VS-W33	Value Shelf for W33
VS-W3324D	Value Shelf for W3324 Deep
VS-W36	Value Shelf for W36
VS-W3624D	Value Shelf for W3624 Deep
VS-W39	Value Shelf for W39
VS-W42	Value Shelf for W42
VS-W6030	Value Shelf for W6030

12", 15" & 18" High Wall Cabinets

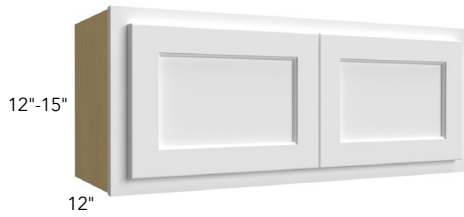

12" - 15" HIGH

ITEM
W3012
W3612
W2415
W3015
W3315
W3615

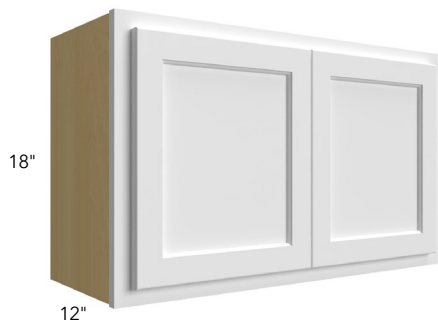

18" HIGH

ITEM
W2418
W3018
W3318
W3618

24" High & 24" Deep Wall Cabinets

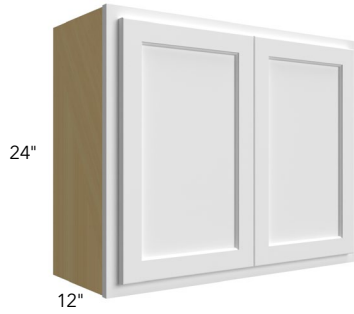

24" HIGH

ITEM
W2424
W3024
W3324
W3624

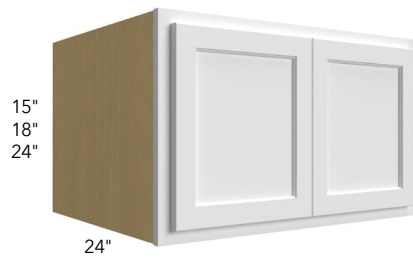

24" DEEP

ITEM
W301524
W331524
W361524
W301824
W331824
W361824
W302424*
W332424*
W362424*

* Has 1 shelf

30" High Wall Cabinets

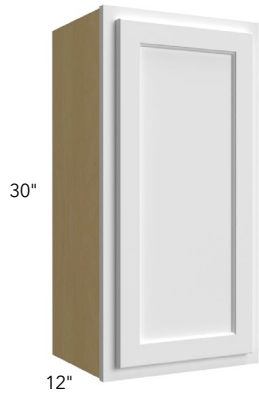

SINGLE DOOR

ITEM
W0930
W1230
W1530
W1830
W2130

- Peninsula modification available on pg. XII

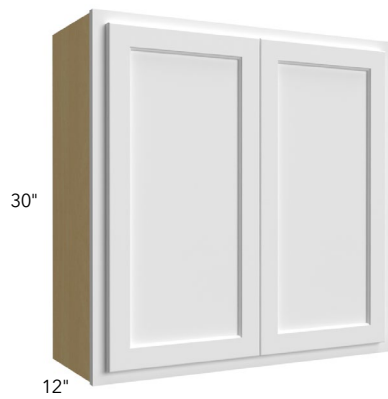

DOUBLE DOOR

ITEM
W2430
W2730
W3030
W3330
W3630

- Peninsula modification available on pg. XII

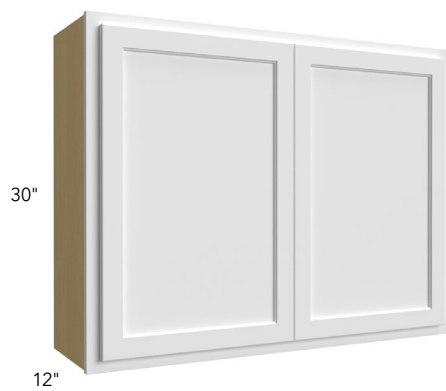

DOUBLE DOOR

ITEM
W3930
W4230

- 1½" center stile
- Peninsula modification available on pg. XII

24" High & 24" Deep Wall Cabinets



60" WIDE COMBINATION

ITEM

W6030

Shelves and clips are shipped together loose and will come packaged separately from the cabinet.



SINGLE DOOR BLIND

ITEM

WBC2430

WBC3030

WBC3630

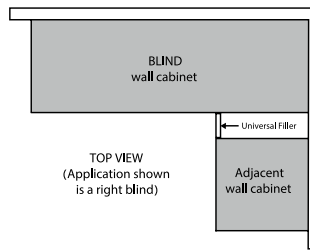

- Must use filler on adjacent side (not supplied)
- Measurements are rounded off to closest 1/8"

	Act.	Max	Door	Stile	Open (door side)
WBC2430	24"	27"	8¾"	6"	7¾"
WBC3030	30"	33"	14½"	6"	13¾"
WBC3630	36"	39"	20½"	6"	19¾"



DOUBLE DOOR BLIND

ITEM

WBC4230

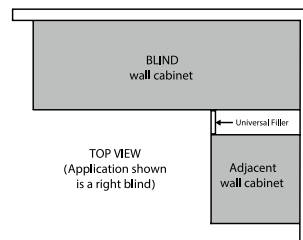

- Must use filler on adjacent side (not supplied)
- Measurements are rounded off to closest 1/8"

	Act.	Max	Door	Stile	Open (door side)
WBC4230	42"	45"	13¼"	6"	25½"

24" High & 24" Deep Wall Cabinets

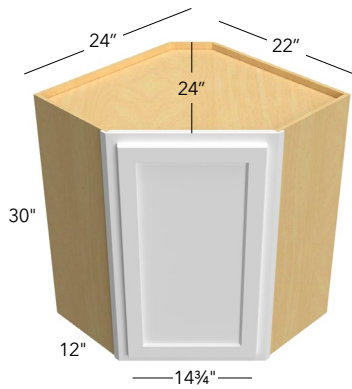

DIAGONAL CORNER

ITEM

WDC2430

- For Lazy Susan see accessories on pg. 27



METRO



DISCOVERY

GLASS DOOR

ITEM

GDD2430*

GD3030♦

GD3630♦

- Glass doors are pre-installed with clear glass only
- * 14 3/4" wide for WDC2430
- ♦ Cost is for a single door - need to order quantity of 2 doors per cabinet

36" High Wall Cabinets

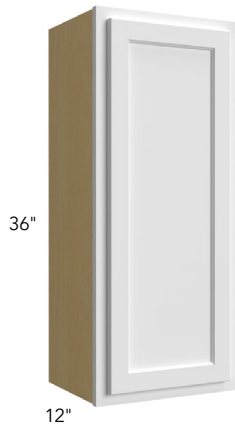

SINGLE DOOR

ITEM
W0936
W1236
W1536
W1836
W2136

- Peninsula modification available on pg. XII



DOUBLE DOOR

ITEM
W2436
W2736
W3036
W3336
W3636

- Peninsula modification available on pg. XII



SINGLE DOOR BLIND

ITEM
WBC2436
WBC3636

- Must use filler on adjacent side (not supplied)
- Measurements are rounded off to closest 1/8"

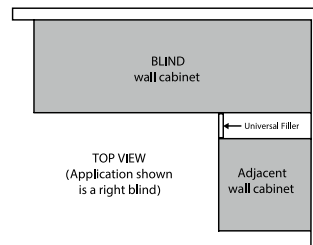

	Act.	Max	Door	Stile	Open (door side)
WBC2436	24"	27"	8¾"	6"	7¾"
WBC3636	36"	39"	20½"	6"	19¾"

36" High Wall Cabinets

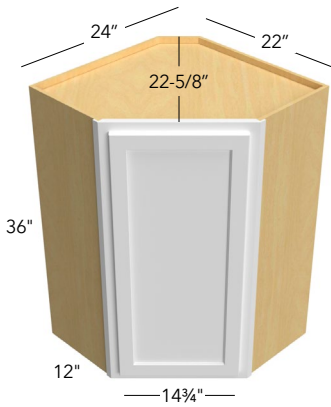

DIAGONAL CORNER

ITEM
WDC2436
<ul style="list-style-type: none"> For Lazy Susan see accessories on pg. 27



METRO

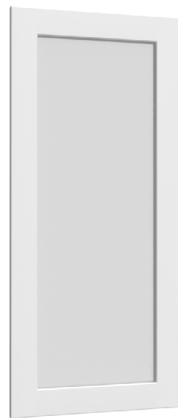

DISCOVERY

GLASS DOOR

ITEM
GDD2436*
GD3036◆
GD3636◆

- Glass doors are pre-installed with clear glass only
- * 14 3/4" wide for WDC2436
- ◆ Cost is for a single door - need to order quantity of 2 doors per cabinet

42" High Wall Cabinets

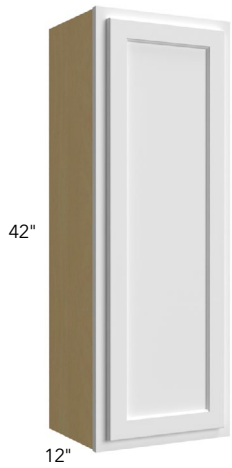

SINGLE DOOR

ITEM
W0942
W1242
W1542
W1842
W2142

- Peninsula modification available on pg. XII



DOUBLE DOOR

ITEM
W2442
W2742
W3042
W3342
W3642

- Peninsula modification available on pg. XII



DOUBLE DOOR

ITEM
W3942

- 1½" center stile
- Peninsula modification available on pg. XII

42" High Wall Cabinets

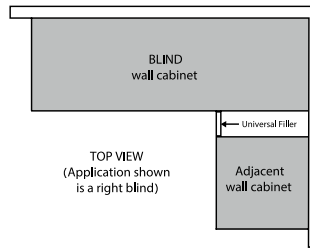
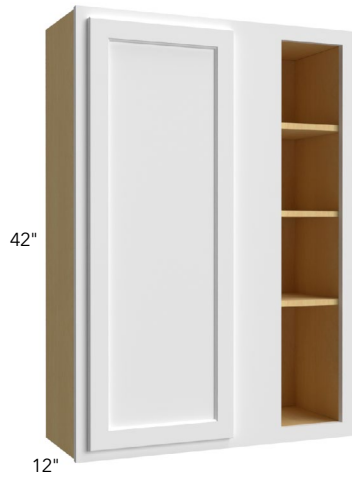

SINGLE DOOR BLIND

ITEM

WBC2442

WBC3642

- Must use filler on adjacent side (not supplied)
- Measurements are rounded off to closest 1/8"

	Act.	Max	Door	Stile	Open (door side)
WBC2442	24"	27"	8 3/4"	6"	7 3/4"
WBC3642	36"	39"	20 1/2"	6"	19 3/4"

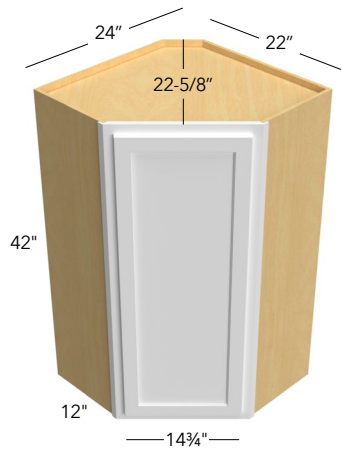

DIAGONAL CORNER

ITEM

WDC2442

- For Lazy Susan see accessories on pg. 27



METRO



DISCOVERY

GLASS DOOR

ITEM

GDD2442*

GD3042♦

GD3642♦

- Glass doors are pre-installed with clear glass only
- * 14 3/4" wide for WDC2442
- ♦ Cost is for a single door - need to order quantity of 2 doors per cabinet

Specialty Wall Cabinets

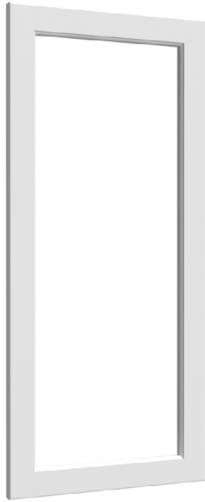

DOOR PREPPED FOR GLASS

ITEM

DFG3030*

DFG3036*

DFG3042*

DFG3630*

DFG3636*

DFG3642*

DFGD2430

DFGD2436

DFGD2442

- Glass not included
 - Comes with the center panel removed; vinyl gasket is included for easy installation of glass in the field.
- * Cost is for a single door, need to order quantity of 2 doors per cabinet

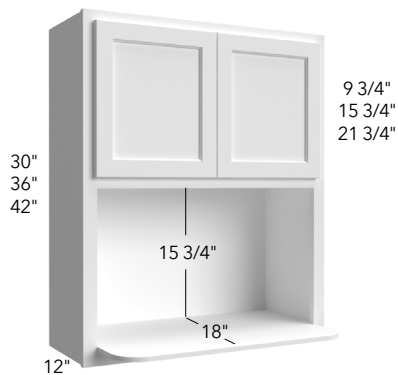

MICROWAVE

ITEM

MW3030

MW3036

MW3042

- Microwave Wall cabinets have been discontinued from Quest. Items are available in limited quantities while supplies last.



**OEL6 SHOWN
(OPENS TO LEFT SIDE)**

OPEN END

ITEM

OEL630

OEL636

OEL642*

OER630

OER636

OER642*

OE1230

OE1236

OE1242*

- * Has 3 shelves

Full Height Door Base Cabinets



FULL HEIGHT SINGLE DOOR

ITEM
B09FD
B12FD
B15FD
B18FD
B21FD



FULL HEIGHT DOUBLE DOOR

ITEM
B24FD
B27FD
B30FD
B33FD
B36FD
B39FD*
B42FD*

* Comes with 1-1/2" wide center stile

Base Cabinets



SINGLE DOOR

ITEM
B09
B12
B15
B18
B21

- B09 accessories available on pg. 25
- Peninsula modification available on pg. XII
- Roll Outs available on pg. 23



DOUBLE DOOR

ITEM
B24
B27
B30

- Peninsula modification available on pg. XII
- Roll Outs available on pg. 23

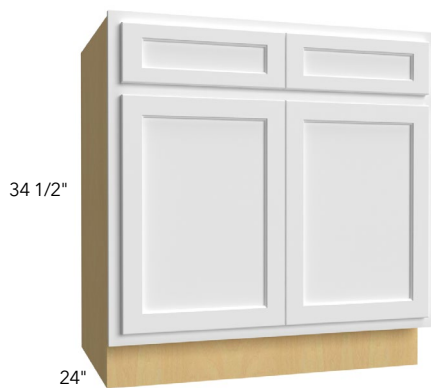

DOUBLE DOOR & DRAWER

ITEM
B33
B36
B39*
B42*

- Roll Outs available on pg. 23
- * Has 3" center stile

Base Cabinets



DRAWER

ITEM

DB12

DB15

DB18

DB24



BLIND

ITEM

BLB36/39

BLB42/45

BLB48/51

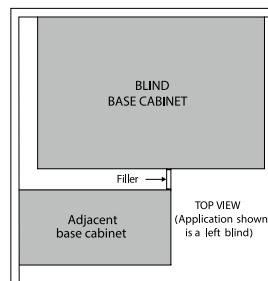

- Must use filler on adjacent side (not supplied)
- Measurements are rounded off to closest 1/8"

	Act.	Min.	Max	Door	Stile	Open
BLB36/39	27"	36"	39"	8 3/4"	8"	8"
BLB42/45	39"	42"	45"	13 1/2"	10 1/2"	12 3/4"
BLB48/51	48"	48"	51"	19 1/2"	7 1/2"	18 3/4"



DIAGONAL SINK FRONT

ITEM

DSF36*

DSFL36-Q♦

- Tilt Out available on pg. 28
- The sink front has a 17" face dimension.
- ♦ DSFL36 - The floor must be ordered separately

Base Cabinets

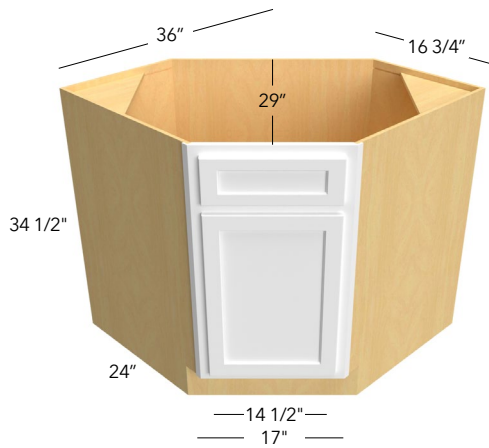

DIAGONAL SINK

ITEM

DSB36

DSB36FD

- *Tilt Out available on pg. 28*

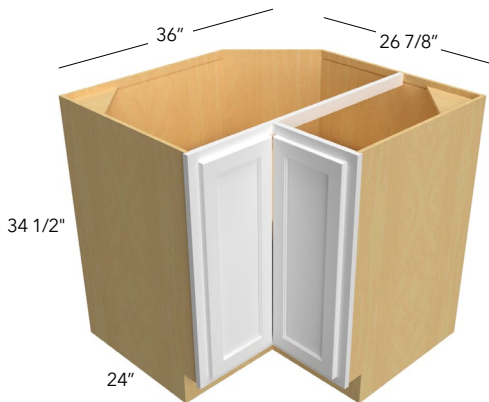

LAZY SUSAN

ITEM

LSB36

- *Includes two 26" Pie-Cut Lazy Susan Trays*
- *Both wooden Lazy Susan trays rotate independently*
- *Center tray is mounted on 15mm (5/8") adjustable shelf*

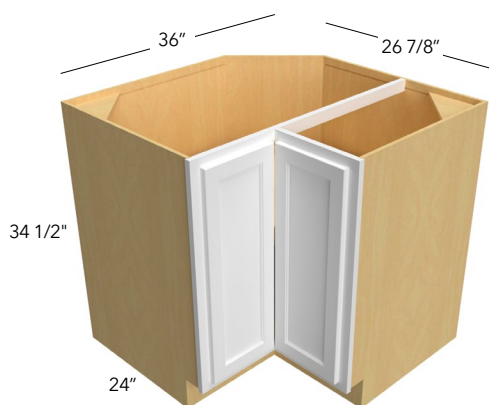

EASY REACH BASE

ITEM

ERB36

- *Center shelf is adjustable*
- *Soft close hinge not available*

Base Cabinets



SINK

ITEM

SB24

SB27

SB30

- *Tilt Out available on pg. 28*



SINK

ITEM

SB33

SB36

SB39*

SB42*

- *Tilt Out available on pg. 28*
- * *Has 3" center stile*

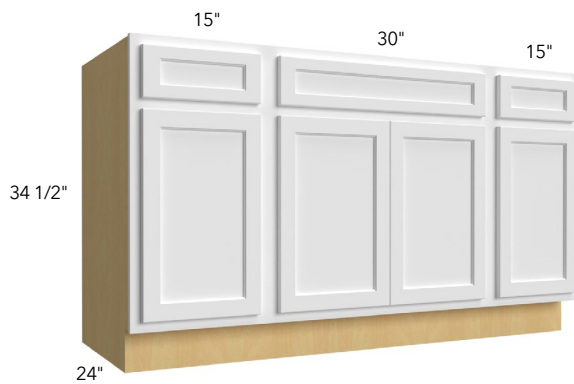

COMBINATION SINK

ITEM

SB60

- *Tilt Out available on pg. 28*

Tall Pantry Cabinets



SINGLE DOOR

ITEM

TP152484

TP182484

TP152490

TP182490

TP152496

TP182496

- 84" high - 5 shelves
- 90" & 96" high - 6 shelves
- Shelves are 18" deep
- Roll Outs available on pg. 23

Tall Pantry shelves and clips are shipped together loose and will come packaged separately from the cabinet.

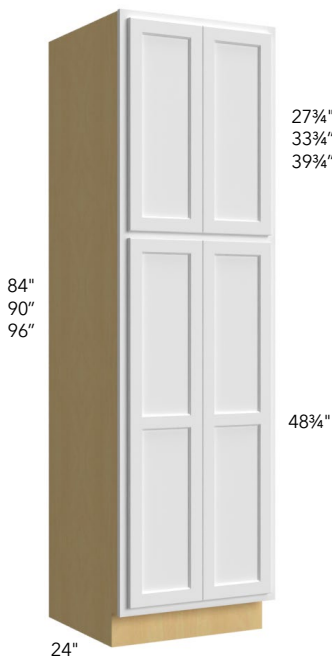

DOUBLE DOOR

ITEM

TP242484

TP242490

TP242496

- 84" high - 5 shelves
- 90" & 96" high - 6 shelves
- Shelves are 18" deep
- Roll Outs available on pg. 23

Tall Pantry shelves and clips are shipped together loose and will come packaged separately from the cabinet.

Vanities



FULL HEIGHT DOOR VANITY BASE

ITEM
VB24FD
VB30FD
VB36FD



VANITY SINK BASE

ITEM
VSB24-34
VSB30-34



VANITY SINK BASE

ITEM
VSB36-34



VANITY DRAWER BASE

ITEM
VDB12-34
VDB15-34

ADA Cabinets

* All ADA cabinets have a 4 1/2" toe kick

Discontinuation Notice: ADA Cabinets have been discontinued from Discovery Frost. Limited quantities available while supplies last.

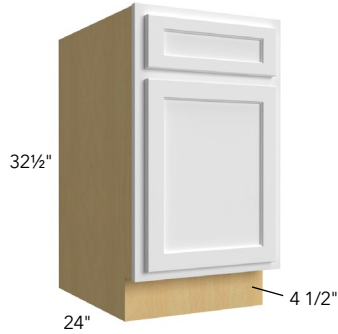

SINGLE DOOR BASE

ITEM

ADA-B12

ADA-B15

ADA-B18

- Peninsula modification available on pg. XII
- Roll Outs available on pg. 23

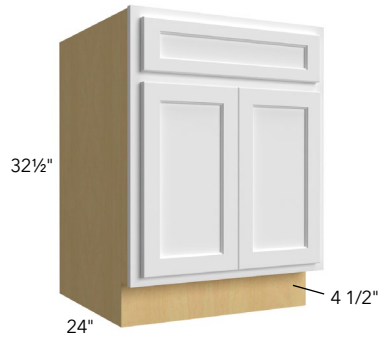

DOUBLE DOOR BASE

ITEM

ADA-B24

ADA-B30

- Peninsula modification available on pg. XII
- Roll Outs available on pg. 23



DOUBLE DOOR & DRAWER BASE

ITEM

ADA-B36

- Peninsula modification available on pg. XII
- Roll Outs available on pg. 23



DRAWER BASE

ITEM

ADA-DB15

ADA-DB24

ADA Cabinets

* All ADA cabinets have a 4½" toe kick

Discontinuation Notice: ADA Cabinets have been discontinued from Discovery Frost. Limited quantities available while supplies last.



SINK BASE - REMOVABLE FRONT

ITEM

ADA-SB30-R

ADA-SB36-R

- Matching interior



VANITY DRAWER BASE

ITEM

ADA-VDB15



VANITY SINK BASE - REMOVABLE FRONT

ITEM

ADA-VSB30-R

ADA-VSB36-R

- Matching interior

Cabinets with Installed Accessories

SPICE PULL OUT

ITEM

B09FD-SPO

B09FD-SPOBLUM

B12FD-SPOBLUM

- Accessory details [pg. 24](#)

TRAY DIVIDER PULL OUT

ITEM

B09FD-TDPOBLUM

- Accessory details [pg. 25](#)

UTENSIL PULL OUT

ITEM

B09FD-UPO

- Accessory details [pg. 25](#)

UTENSIL KNIFE PULL OUT

ITEM

B12FD-UKBPOBLUM

- Accessory details [pg. 25](#)

TRASH CAN

ITEM

B15-TC

B18-TC

B21-TC

B15FD-TC

B18FD-TC

B21FD-TC

- Accessory details [pg. 22](#)

SINGLE DOOR ROLL OUT DRAWERS

ITEM

B12-1RODE

B12-2RODE

B15-1RODE

B15-2RODE

B18-1RODE

B18-2RODE

B21-1RODE

B21-2RODE

DOUBLE DOOR ROLL OUT DRAWERS

ITEM

B24-1RODE

B24-2RODE

B27-1RODE

B27-2RODE

B30-1RODE

B30-2RODE

B33-1RODE

B33-2RODE

B36-1RODE

B36-2RODE

B42-1RODE

B42-2RODE

B42-3RODE

B42-4RODE

- Only partial extension available for Quest Roll Out Drawers [pg. 23](#)
- Roll out drawers will be assembled and installed according to the quantity purchased. For custom height-placement, please email orders@fabuwood.com. A \$100 modification surcharge will apply to all custom requests.

Cabinets with Installed Accessories

SINGLE DOOR FULL HEIGHT ROLL OUT DRAWERS

ITEM
B12FD-1RODE
B12FD-2RODE
B12FD-3RODE
B15FD-1RODE
B15FD-2RODE
B15FD-3RODE
B18FD-1RODE
B18FD-2RODE
B18FD-3RODE
B21FD-1RODE
B21FD-2RODE
B21FD-3RODE

DOUBLE DOOR FULL HEIGHT ROLL OUT DRAWERS

ITEM
B24FD-1RODE
B24FD-2RODE
B24FD-3RODE
B27FD-1RODE
B27FD-2RODE
B27FD-3RODE
B30FD-1RODE
B30FD-2RODE
B30FD-3RODE
B33FD-1RODE
B33FD-2RODE
B33FD-3RODE
B36FD-1RODE
B36FD-2RODE
B36FD-3RODE

SINGLE DOOR TALL PANTRY ROLL OUT DRAWERS

ITEM
TP152484-2RODE
TP152484-3RODE
TP152484-4RODE
TP152490-2RODE
TP152490-3RODE
TP152490-4RODE
TP152496-2RODE
TP152496-3RODE
TP152496-4RODE
TP182484-2RODE
TP182484-3RODE
TP182484-4RODE
TP182490-2RODE
TP182490-3RODE
TP182490-4RODE
TP182496-2RODE
TP182496-3RODE
TP182496-4RODE

DOUBLE DOOR TALL PANTRY ROLL OUT DRAWERS

ITEM
TP242484-2RODE
TP242484-3RODE
TP242484-4RODE
TP242490-2RODE
TP242490-3RODE
TP242490-4RODE
TP242496-2RODE
TP242496-3RODE
TP242496-4RODE

- Only partial extension available for Quest Roll Out Drawers [pg.23](#)
- Roll out drawers will be assembled and installed according to the quantity purchased. For custom height-placement, please email orders@fabuwood.com. A \$100 modification surcharge will apply to all custom requests.

Waste Solutions

TC18 BLUM, TC21 BLUM



TC15 BLUM



TRASH CAN (W/ BLUM SLIDES)

ITEM

TC15 BLUM*

TC18 BLUM

TC21 BLUM

TCV15 BLUM◆

- Cabinet not included, cabinet must be ordered separately
- Tandem plus Blumotion full extension concealed drawer runners
- 2 - 35 qt. cans included
- Not for ADA cabinet use
- * Single 35 qt. can + one bags bin
- ◆ Smaller depth for vanity cabinets 21" deep

TC18FHD BLUM, TC21FHD BLUM



TC15FHD BLUM



TRASH CAN FULL HEIGHT DOOR (W/ BLUM SLIDES)

ITEM

TC15FHD BLUM*

TC18FHD BLUM

TC21FHD BLUM

- Cabinet not included, cabinet must be ordered separately
- Tandem plus Blumotion full extension concealed drawer runners
- 2 - 50 qt. can included
- Not for ADA cabinet use
- FULL-DOORS modification is required
- * Single 50 qt. can + one bags bin

Base Accessories



ROLL OUT (PARTIAL EXTENSION BLUM SLIDES)

ITEM
ROD-B15 BLUM E
ROD-B18 BLUM E
ROD-B21 BLUM E
ROD-B24 BLUM E
ROD-B27 BLUM E
ROD-B30 BLUM E
ROD-B33 BLUM E
ROD-B36 BLUM E

- Cabinet not included
- Price is for a single Roll Out drawer
- Blumotion partial extension concealed drawer runners
- Drawers are adjustable
- Can be used for pantries

For increased drawer depth or custom height-placement, please email orders@fabuwood.com.

A \$100 modification surcharge will apply to all custom requests.

Base Accessories



TWO-TIER COOKWARE ORGANIZER

ITEM

CWO-B18 BLUM

CWO-B24 BLUM

- Cabinet not included
- Full-extension Blum slides
- Pegboard bottoms
- 4 Press-in pegs included



3" TOWEL BAR PULL OUT

ITEM

TBPO-BF3

- Filler & Overlay Filler are required and need to be ordered separately
- 2 Towel bars
- Single static shelf with chrome wire accents
- UV coated maple wood
- Installed on site
- Installed between two cabinets
- Full-extension, ball-bearing slides with soft-close



SPICE PULL OUT BASE

ITEM

SPO-B9*

SPO-B9 BLUM

SPO-B12 BLUM

- Cabinet not included, cabinet must be ordered separately
- FULL-DOORS modification is required
- Chrome rails
- Adjustable shelves
- UV coated maple wood
- Not for ADA cabinet use
- * Full extension ball-bearing slides (not soft-close)

Base Accessories



UTENSIL PULL OUT BASE 9" (W/ BLUM SLIDES)

ITEM

UPO-B9 BLUM

- Cabinet not included, cabinet must be ordered separately
- FULL-DOORS modification is required
- Chrome rails
- Adjustable shelves
- UV coated maple wood
- Not for ADA cabinet use
- Features Blumotion soft-close drawer slides

UKBPO-B12 BLUM



UKBPO-B15 BLUM



UTENSIL & KNIFE PULL OUT

ITEM

UKBPO-B12 BLUM

NEW! UKBPO-B15 BLUM

- Cabinet not included, cabinet must be ordered separately
- Designed for full height base cabinet
- Knife block features flex rod technology that adjust to securely hold knives
- Chrome rails
- Adjustable top shelf
- Removable stainless steel bin(s) included
 - » UKBPO-B12 BLUM: Includes one 2 qt. bin
 - » UKBPO-B15 BLUM: Includes one 2 qt. bin & three 1 ¼ qt. bins
- 4 flexible plastic cutting mats included
- UV coated maple wood
- Not for ADA cabinet use
- Features Blumotion soft-close drawer slides

TRAY DIVIDER PULL OUT BASE 9" (W/ BLUM SLIDES)

ITEM

TDPO-B9 BLUM



- Cabinet not included, cabinet must be ordered separately
- FULL-DOORS modification is required
- UV coated maple wood
- Not for ADA cabinet use
- Features Blumotion soft-close drawer slides

Base & Wall Accessories



SPICE PULL OUT BASE FILLER

ITEM
SPO-BF3*
SPO-BF6*
SPO-BF3 BLUM
SPO-BF6 BLUM

- Filler required - must be ordered separately
 - 30" high Wall Filler recommended instead of Base Filler. Requires toe kick to be built separately.
 - Chrome rails
 - Adjustable shelves
 - UV coated maple wood
 - Installed on site
 - Installed between two cabinets
 - Not for ADA cabinet use
- * Full extension ball-bearing slides (not soft-close)



SPICE PULL OUT WALL FILLER

ITEM
SPO-WF330
SPO-WF336
SPO-WF342
SPO-WF630
SPO-WF636
SPO-WF642

- Filler required - must be ordered separately
- Chrome rails
- Full extension ball-bearing slides (not soft-close - BLUM slides not available)
- Adjustable shelves
- UV coated maple wood
- Installed on-site
- Installed between two cabinets

Wall Accessories



LAZY SUSAN

ITEM

PLASTIC

WOOD

LSP24 30

LSP24 36/42

- Adjustable metal post
- 42" lazy susan has 3 trays
- 42" poles can be cut to fit 36" high cabinet
- Prepared for installation at job site

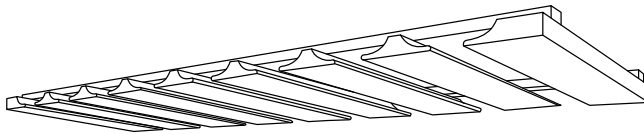

STEMWARE RACK

ITEM

LSW24 30

LSW24 36/42

- Comes unfinished. Product finished per order. May have extended ETA.

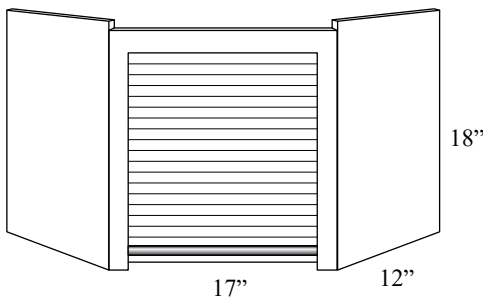

CORNER APPLIANCE GARAGE

ITEM

STMW30

- Comes unfinished. Product finished per order. May have extended ETA.
- Designed to be installed under a diagonal corner wall 24".

Note: Appliance garages ship unassembled. Assembly required for installation on-site.

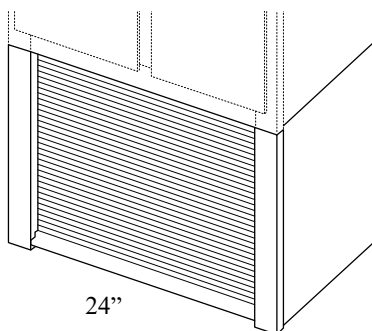

STRAIGHT APPLIANCE GARAGE

ITEM

STMW36

- Comes unfinished. Product finished per order. May have extended ETA.
- Designed to be placed under a 24" wide wall cabinet.
- Stiles are 2" wide

Note: Appliance garages ship unassembled. Assembly required for installation on-site.

Sink Accessories



TILT OUT

ITEM
WDCAG2418
WAG24218
TILTOUT 11"

- White plastic tray

UNDER SINK MAT

ITEM
NEW! TILTOUT 14"

- Product will be cut to size when purchased as accessory for cabinet.
- Product Purchased Separately will ship loose in 48"x30" Sheets.
- Grey waterproof polystyrene mat with stainless steel detail



Drawer Accessories



CUTTING BOARD & KNIFE DRAWER

ITEM

TILTOUT 24"

- For 18" cabinet drawer only
- Replaces the original drawer box of cabinet
- UV coated maple wood
- Up to 4 compartments and built-in knife organizer
- 1 wooden cutting board
- Blumotion full extension concealed drawer runners



CHARGING DRAWER

ITEM

UNDER SINK MAT

- For 18" cabinet drawer only
- Replaces the original drawer box of cabinet
- UV coated maple wood
- Blumotion full extension concealed drawer runners
- (2) 120V plugs and (2) 201 amp USB ports
- Tamper resistant outlets
- Max current: AC: 12 amps @ 120VAC; USB 2.1 amp & 5 VDC
- Power cord with NEMA 5 - 15 plug
- Integrated cord guide to ensure safe operation
- Shock absorbent mat, black
- Overall safety of this product is determined by its end use



2-TIER CUTLERY DRAWER

ITEM

CBKD-B18 BLUM

CHD-B18 BLUM

DCD-15 BLUM

DCD-18 BLUM

DCD-21 BLUM

DCD-24 BLUM

- UV coated maple wood
- Includes complete 3¾" high drawer box
- Blumotion full-extension concealed drawer runners

Drawer Accessories



TRIMMABLE KNIFE DIVIDER

ITEM

DCD-30 BLUM

- UV coated maple wood
- Total height: 2"
- 3/8" plywood bottom

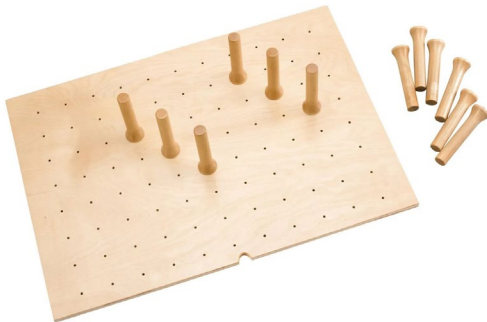

DRAWER PEGBOARD SYSTEM

ITEM

NEW! DCD-36 BLUM

NEW! DKI-18/24

- Compatible with Three Drawer Base Cabinets (middle and bottom drawers only) and Two Drawer Base Cabinets
- Boards are cut-to-size during assembly to fit the drawer box (includes installation)
- Maple wood with semi-gloss finish
- Pre-drilled placement holes are 2 1/2" apart in both directions
- Available as loose accessory (to be trimmed on site)
- DPS-18/27:
 - » To fit 18" - 27" drawer
 - » Includes nine 6" tall adjustable peg inserts
- DPS-30/33:
 - » To fit 30" - 33" drawer
 - » Includes twelve 6" tall adjustable peg inserts

Vanity Accessories



VANITY OUTLET GROOMING ORGANIZER

ITEM

DPS-18/27

- Cabinet not included, cabinet must be ordered separately
- FULL-DOORS modification required
- 2 removable stainless steel bins included
- 2 shelves with non-skid vinyl lining and acrylic accents
- In-drawer receptacle with (2) 120V plugs
- Tamper-resistant outlets
- Max Current: AC: 12 amps @ 120VAC
- Power cord with NEMA 5 - 15 plug
- Integrated cord guide ensures safe operation
- Drawer stop prevents items from being stored "ON" inside the cabinet
- Its end-use determines the overall safety of this product
- UV coated maple wood
- Not for ADA cabinet use
- Blumotion full extension concealed drawer runners



VANITY APPLIANCE STORAGE RACK

ITEM

DPS-30/33

- Designed for 30" vanity base cabinet
- Mounts to inside of right or left door
- Non-skid lining on lower level shelf
- (2) 1.25 qt. stainless steel bins
- UV coated maple wood



VANITY ORGANIZER PULL OUT

ITEM

VGO12FD BLUM

- Reversible
- 6 Acrylic bins included
- Blumotion full extension concealed drawer runners
- For VSB24-34

*Pull-out's shorter depth is designed for 24" Vanity Sink Base, but will also work in standard depth base cabinets. If used in standard base, there will be additional space in rear of cabinet once unit is installed.

Drawer Accessories



U-SHAPED VANITY SINK BASE PULL OUT

ITEM

VASR-30

- Tandem plus Blumotion full extension drawer runners
- Designed for 30" Vanity Sink Base, but works great in standard depth base cabinets as well
- Non-skid vinyl lining
- 4 adjustable dividers
- 8 qt. waste container included

Any accessories can be ordered and installed through Fabuwood

Fillers & Valance

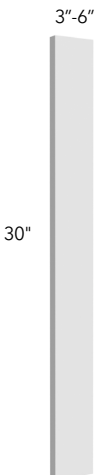
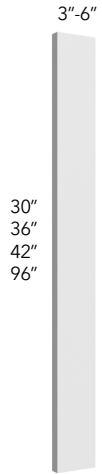

WALL & TALL FILLER

ITEM

VOPO-24 BLUM

UVTCPO-30 BLUM

WF330

WF336

WF342

WF630

WF636

WF642

TF396

TF696

- 2 sides of filler are finished

BASE FILLER

ITEM

BF3

BF6

- Base Fillers are finished on long edges and front face

STRAIGHT VALANCE

ITEM

VST96

Moldings (8')

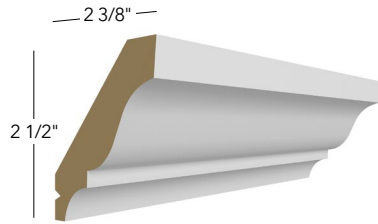

SMALL CROWN

ITEM

CM-1

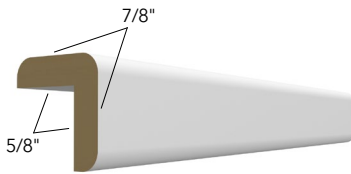

OUTSIDE CORNER

ITEM

OCM8



INSIDE CORNER

ITEM

ICM8

Moldings (8')



QUARTER ROUND

ITEM

QRM

- Available in Discovery Frost only



SCRIBE

ITEM

SM8



BATTEN

ITEM

BM3/4

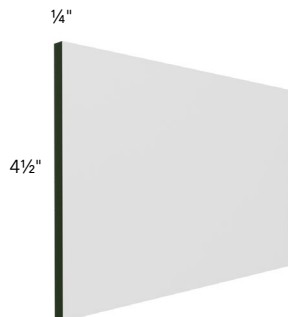

TOE KICK

ITEM

TK8

- Exterior finish matches that of door style ordered
- Moisture Resistant MDF will have visible green core

Panels

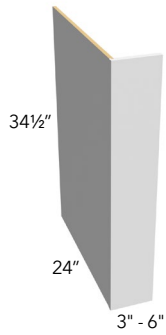

DISHWASHER END PANEL

ITEM

NEW! DWR1-1/2

DWR3

DWR6

- Sides are flush finished (no 1/4" reveal)

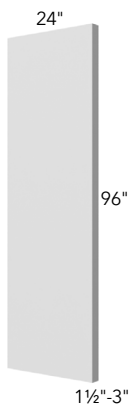

REFRIGERATOR END PANEL WITH RETURN

ITEM

REP1-1/2

REP3

- Sides are flush finished (no 1/4" reveal)

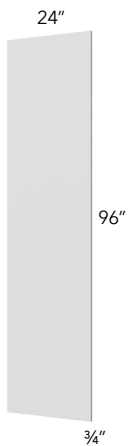

REFRIGERATOR END PANEL

ITEM

REP2496

- Edge banded on both 96" sides.

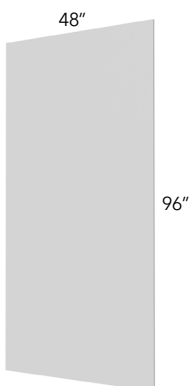

PLYWOOD

ITEM

PAN-1/4*

PLY-1/2

PLY-3/4

- Moisture Resistant MDF will have visible green core

Paint & Touch Up Kits



PAINT

ITEM

PAINT

- Available in Frost
- Can be ordered by the Pint or Quart Gallon.
Quart sizes will be shipped out in the equivalent amount of 1-Pint size cans to fulfill the order.

DISCLAIMER: Fabuwood takes no responsibility for improper application and/or imperfections caused by using this item. Touch-ups & Finishing applications are recommended to be completed by a qualified cabinet installer.



PAINT SPRAY CAN

ITEM

PSC

- Available in Frost only
- Paint Spray Can can be used for general touch-ups.
Suggested Uses: Spraying the edges of molding before installation, cosmetic touch-up after installation, spraying the edges of TK8 or loose PAN-1/4 finished end skins.
- Note: Not intended to be used to refinish a cabinet or accessory such as trim moldings.
- Due to the complexity of Fabuwood finishes, Paint Spray Cans are not available for stained finishes.

DISCLAIMER: Fabuwood takes no responsibility for improper application and/or imperfections caused by use of Paint Spray Can. Touch-ups are recommended to be completed by a qualified cabinet installer.



TOUCH UP KIT

ITEM

TOUCH UP KIT

- Includes stick, marker, & scraper

Under-Cabinet Lighting

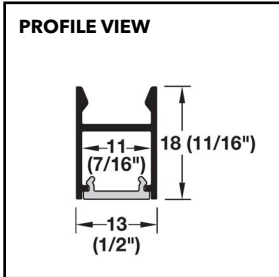

UNDER CABINET LED

ITEM

LED W09

LED W12

LED W15

LED W18

LED W21

LED W24

LED W27

LED W30

LED W33

LED W36

LED W39

- Dimmable. Settings allow for adjustment between Warm White to Cool White lighting
- Light temperature range of 2700-5000K
- LED Lighting bars are designed to be surface-mounted underneath a wall cabinet
- Consists of an aluminum channel housing with diffuser cover
- Requires Power Supply Starter Kit, or Power Supply & Recommended Light Switch (purchased separately).

Note: Installation by a qualified cabinetry installer or electrician is recommended.



PUCK LIGHT

COVER CAP

LEAD

PUCK LIGHT SET

ITEM

NEW! LED 2-1/4" PUCK

- Designed to recess into the bottom of a cabinet or soffit box.
- Includes puck light, silver cover cap, and lead
- Light temperature range of 2700-5000K
- Requires Power Supply Starter Kit, or Power Supply & Recommended Light Switch (purchased separately).

Note: Installation by a qualified cabinetry installer or electrician is recommended.

Under Cabinet Lighting



LED FLS30 WALNUT SHOWN

FLOATING SHELF WITH LED

ITEM
LED FLS24
LED FLS30
LED FLS36
LED FLS42
LED FLS48
LED FLS54
LED FLS24 WALNUT
LED FLS30 WALNUT
LED FLS36 WALNUT
LED FLS42 WALNUT
LED FLS48 WALNUT
LED FLS54 WALNUT

- Dimmable. Settings allow for adjustment between Warm White to Cool White lighting
- Light temperature range of 2700-5000K
- Floating shelves include a Light Bar with 6.5ft Lead and a 6.5ft Extension Lead
- LED Light Bar for Floating Shelves ship loose and are to be installed in the field
- Floating Shelves with LED are available in Stock Paint and Stain Finishes, Walnut and are to be specified at time of order. For Finishing to a custom color, must be ordered as Dove or Frost.
- Requires Power Supply Starter Kit, or Power Supply & Recommended Light Switch (purchased separately).

Note: Installation by a qualified cabinetry installer or electrician is recommended.

LED INTERIOR CABINET LIGHTING

ITEM
NEW! LED CAB INT 48" STRIP



- Flexible LED Lighting Strip designed for interior cabinet lighting.
- Strip can be trimmed in 2" intervals to fit as needed
- Medium Intensity lighting
- Requires Power Supply Starter Kit, or Power Supply & Recommended Light Switch (purchased separately).

Note: Installation by a qualified cabinetry installer or electrician is recommended.

Under Cabinet Lighting

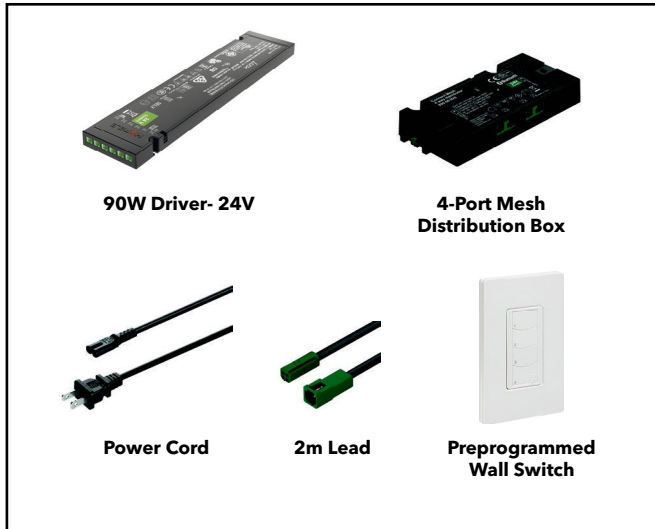

Zone Control Kit Contents & Qty per number of Zones	1 Zone	2 Zones	3 Zones	4 Zones
90w Driver (24V) with power cord	1	2	3	4
2m (6.5ft) Extension Lead to Connect to First Light	1	2	3	4
4-Port Mesh Distribution Box, Bluetooth Enabled	1	2	3	4
Preprogrammed Wall Switch (Bluetooth Enabled, Leviton Decora)	1	1	1	1



POWER SUPPLY STARTER SET

ITEM

LED SKIT WLS 1Z

LED SKIT WLS 2Z

LED SKIT WLS 3Z

LED SKIT WLS 4Z

- Power Supply Starter sets with Zone Controls come with the following components:
 - 90w Driver, 24V with power cord
 - 2m (6.5ft) Extension Lead to Connect First Light
 - 4-Port Mesh Distribution Box (Bluetooth-enabled, pairs with Wall Switch)
 - One (1) Preprogrammed Wall Switch with Dimmer Function
- Starter Sets should be ordered based on the number of Lighting Zones needed. Starter Kit components quantities are based on zone quantity.
- Each Power Supply Driver requires a 110V standard power outlet
- If more than (4) zones are needed: purchase additional Power Supply Starter Sets depending on additional quantity of zones needed. Additional Wall Switch LED WLS SWITCH is available for purchase.
- Consult the following page or the Ordering Guide for instructions on determining zones and for layout examples.

NOTE: Maximum amount of 10ft per zone is advised. Cabinetry runs greater than 10ft are considered 2 zones (or more).

Installation by a qualified cabinetry installer or electrician is recommended

ADDITIONAL WIRELESS WALL LIGHT SWITCH

ITEM

LED WLS SWITCH

- Leviton Decora-style Wall Switch with Dimmer Function

Note: Installation by a qualified cabinetry installer or electrician is recommended.

Under Cabinet Lighting

ORDERING GUIDE

Ordering Loox Kitchen Lighting can be completed within a few steps. We will outline those steps below so that you can specify the products that work best for your kitchen.

DETERMINE ZONES

Determine how many total light zones are in the kitchen; a zone is determined by a continuous run of cabinets. Any separation in the wall cabinets including windows, range hoods, doors, etc. creates a break and may create another zone. If a zone is greater than 10' consider it 2 zones. Make sure there is a 110 V power outlet for each zone either in the cabinet or immediately above the cabinet. See examples of zone illustrations below:

Layout Examples

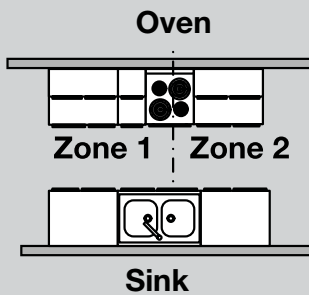

GALLEY

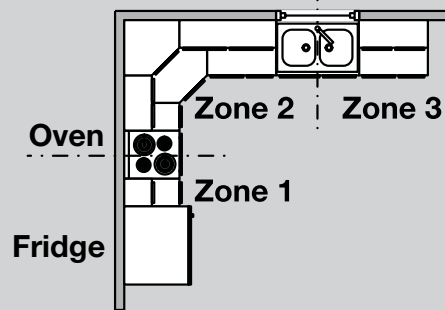

L-SHAPE

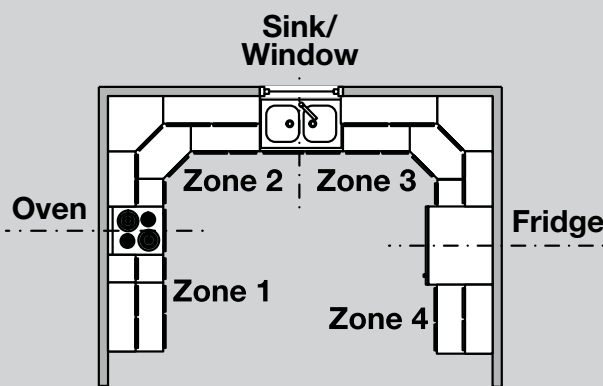

U-SHAPE

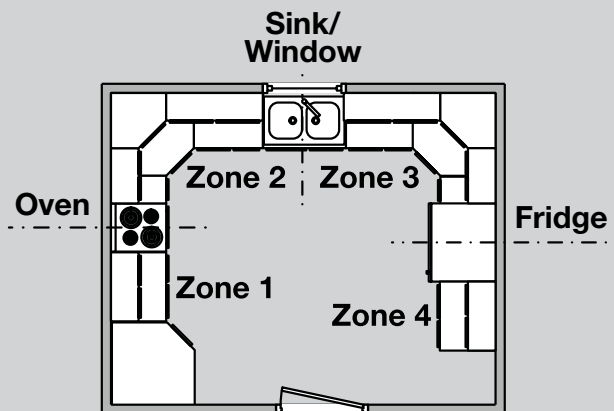

G-SHAPE

Height Alignment Guide

84" Height Alignment

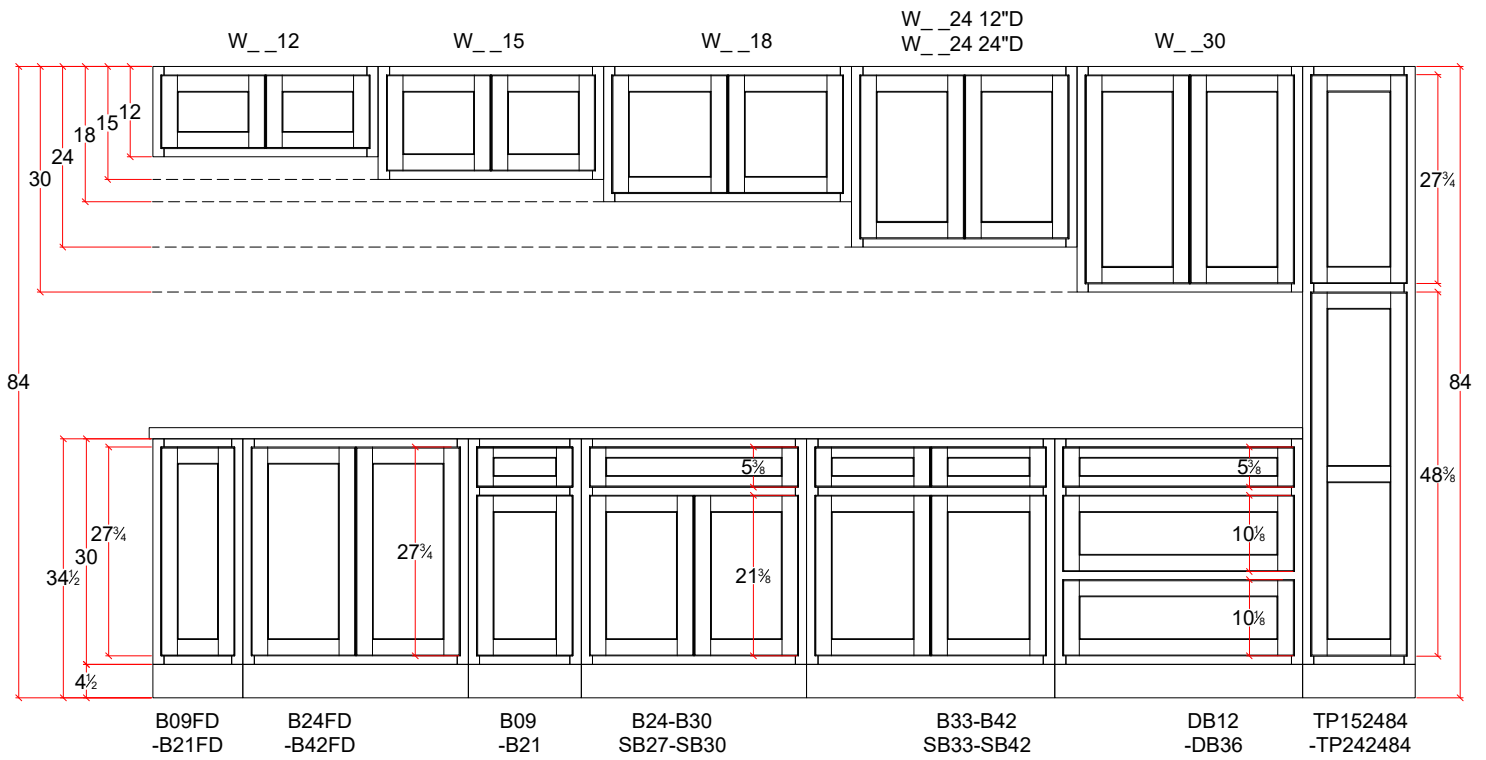

90" Height Alignment

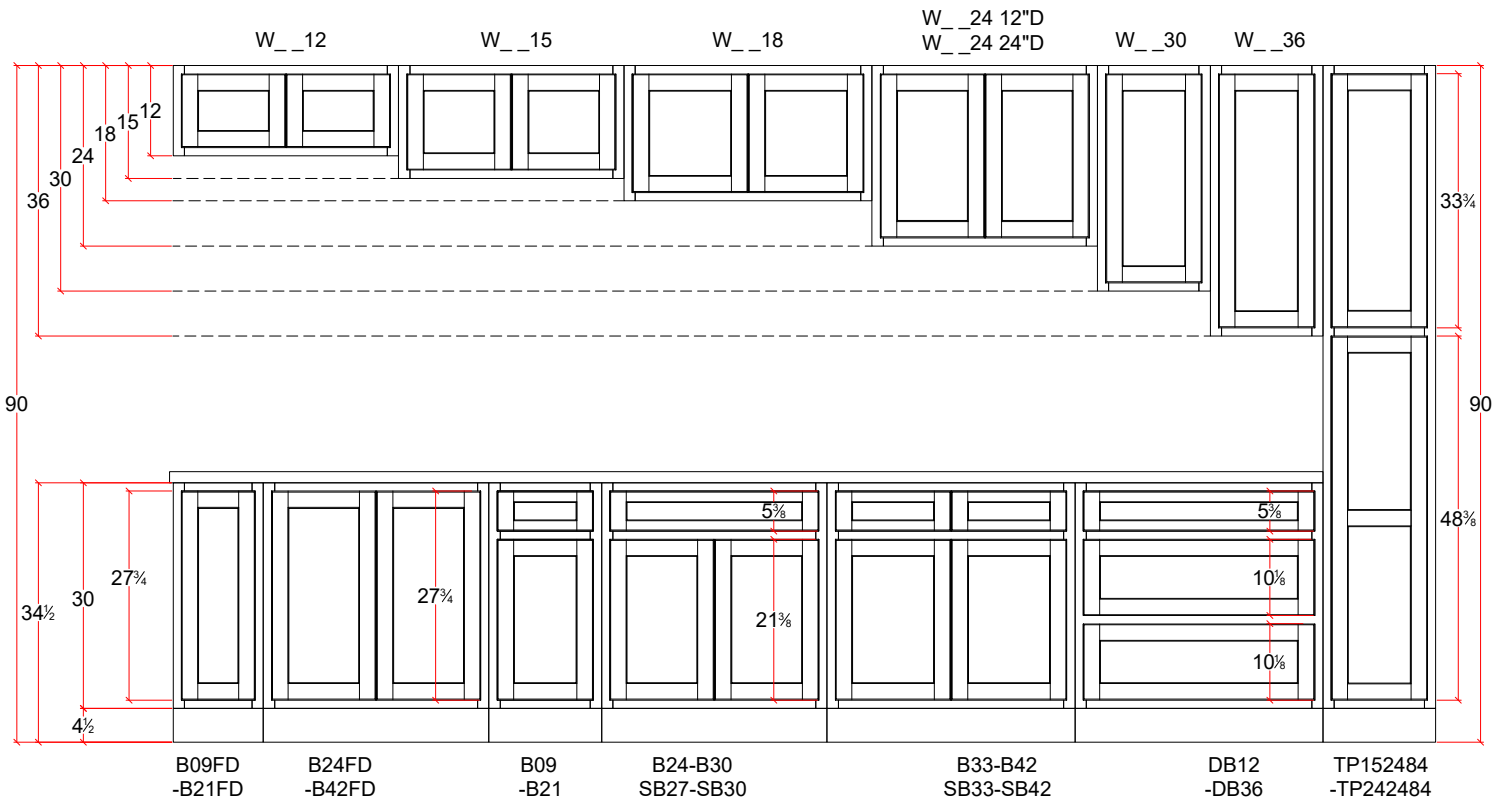

96" Height Alignment

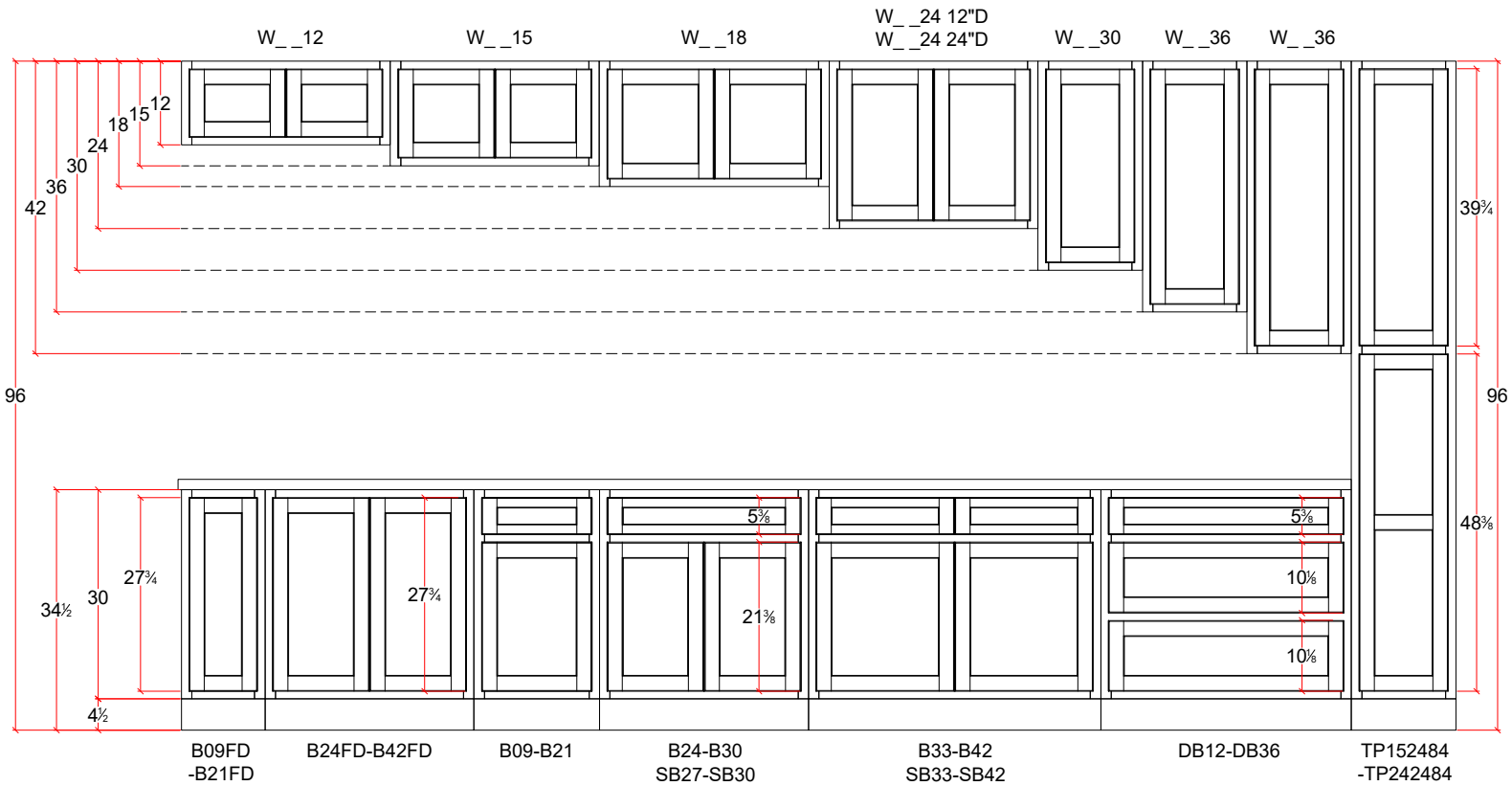

Copyright © 2024 by Fabuwood Cabinetry Corp.

All rights reserved.

No part of this publication may be reproduced, distributed, or transmitted in any form or by any means, including photocopying, scanning, or other electronic or mechanical methods, including online sharing, without the prior written permission of Fabuwood Cabinetry Corp.

